

SHOCK BLADE

ORDER FORM
Ver. 9.1 Rev-120513



Tel: 951-808-9131 FAX: 951-808-9949
Toll Free: 800-892-8998 www.colourswheelchair.com

DEALER			COLOURS INFORMATION For Office Use Only		
Dealer:			Order Date: S/N:		
Account:		P.O.#:	RTS		
Ordered By:			RTS: Phone:		
Address:			Email:		
City:		State:	SHIP TO		
Phone:		Fax:	Name: Ship Via:		
Email:			Address:		
Customer Name:			City: State: Zip:		
Customer Weight:			Phone: Fax:		

CHAIR INFORMATION	PRICE
New SHOCK BLADE K0005	Base Wheel Chair Price K0005 \$ 2,400
Fixed FSH-RSH with Air Ride System Suspension (E1015)	Air Ride System \$ 1,380
Max. Capacity 250Lbs	Total Section A \$
NOTE	Total Section B \$
Main Frame : Lifetime Warranty	Total Section C \$
*See warranty policy	Total Section D \$
	Total Section E \$
	Total Section F (Custom Parts Color) \$
	ORDER GRAND TOTAL

A FRAME COLORS & PARTS COLORS

FRAME COLORS		
Powder-Coated	<input type="checkbox"/> Gloss Black <input type="checkbox"/> Twilight Flake <input type="checkbox"/> Yellow <input type="checkbox"/> Magenta <input type="checkbox"/> Fire Engine Red <input type="checkbox"/> White <input type="checkbox"/> Candy Blue <input type="checkbox"/> Candy Purple <input type="checkbox"/> Candy Green <input type="checkbox"/> Candy Red <input type="checkbox"/> Candy Raspberry <input type="checkbox"/> Cobalt Blue <input type="checkbox"/> Matte Gray <input type="checkbox"/> Matte Purple <input type="checkbox"/> Matte Blue <input type="checkbox"/> Matte Green <input type="checkbox"/> Matte Black <input type="checkbox"/> Matte Red <input type="checkbox"/> Neon Red <input type="checkbox"/> Neon Green <input type="checkbox"/> Orange Sparkle <input type="checkbox"/> Mellon Yellow <input type="checkbox"/> Gun Smoke Silver <input type="checkbox"/> Pigeon Blue <input type="checkbox"/> Granny Sparkle Green <input type="checkbox"/> Sparkle Sky Blue <input type="checkbox"/> Vermilion <input type="checkbox"/> Reed Green <input type="checkbox"/> Blue Lilac	\$ STD
Special	<input type="checkbox"/> Polished <input type="checkbox"/> 24 karat Gold	\$ 800 \$ CFP

PARTS COLORS (Custom Parts Color Section, Please see Section F)		
STD Color	Black Color (*Suspension Springs-Silver Color Only)	\$ STD
Custom Color Main Bolt on Parts One Color Package	Including: Backrest, Foot Plate, Footrest Rings, Backrest Brackets, Saddle Stops, Forks & Knurl Nuts, Caps, Front Suspension Springs ☆marked parts <input type="checkbox"/> Powder-Coated (.....) .. <input type="checkbox"/> Polished <input type="checkbox"/> 24 karat Gold	\$ 500 \$ 750 \$ CFP
Custom Color Suspension Unit One Color Package	Including: Axle Plates, Camber Discs, Upper A-Arms, Lower A-Arms, Suspension Main Frame ☆marked parts <input type="checkbox"/> Powder-Coated (.....) .. <input type="checkbox"/> Polished <input type="checkbox"/> 24 karat Gold	\$ 380 \$ 800 \$ CFP

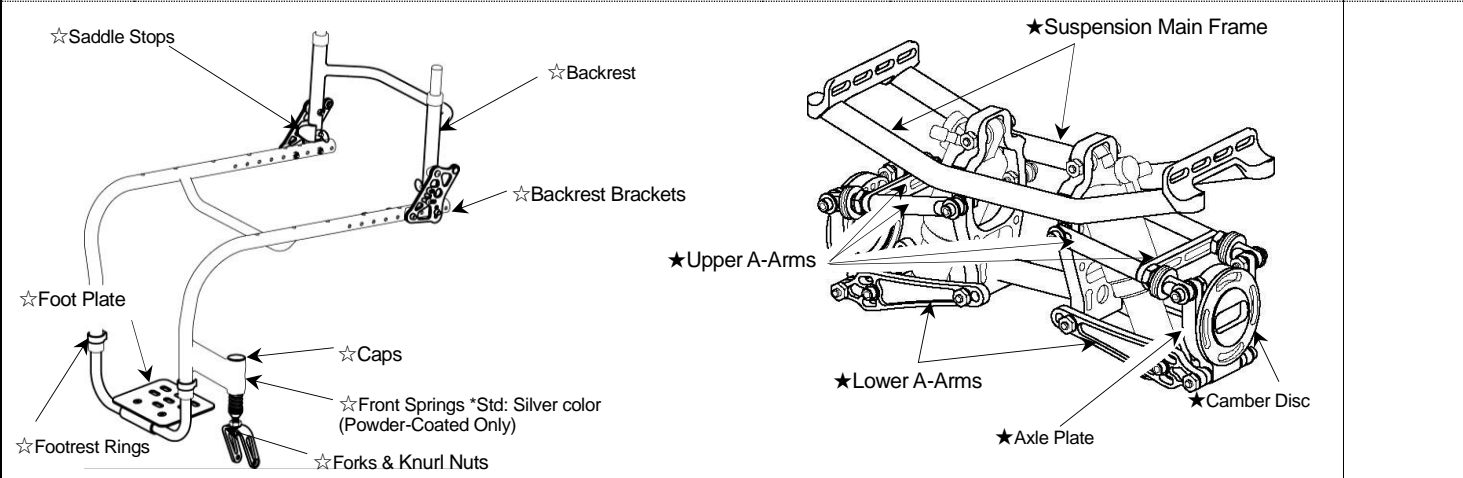

Total Section A \$

B FRAME MEASUREMENTS 1/2

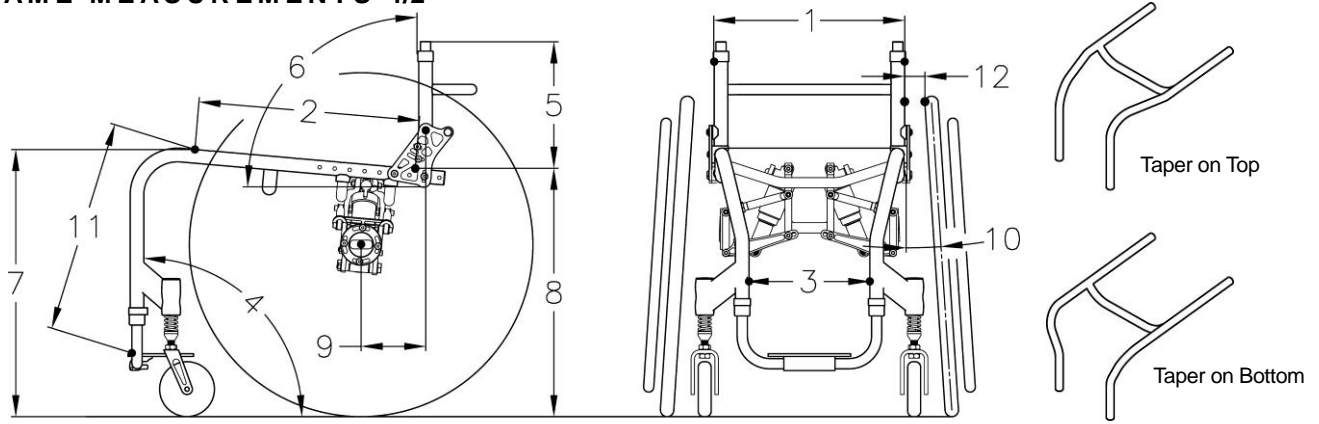

1. SEAT WIDTH	<input type="checkbox"/> 13" <input type="checkbox"/> 14" <input type="checkbox"/> 15" <input type="checkbox"/> 16" <input type="checkbox"/> 17" <input type="checkbox"/> 18" <input type="checkbox"/> 19"	\$	STD								
2. SEAT DEPTH * Only Choose One Option	<input type="checkbox"/> Net Seat Depth <input type="checkbox"/> 13" <input type="checkbox"/> 14" <input type="checkbox"/> 15" <input type="checkbox"/> 16" <input type="checkbox"/> 17" <input type="checkbox"/> 18" <input type="checkbox"/> 19"	\$	STD								
	<input type="checkbox"/> Depth Adj. Frame <input type="checkbox"/> Short Frame (16" Depth) Set at <input type="checkbox"/> 13" <input type="checkbox"/> 14" <input type="checkbox"/> 15" <input type="checkbox"/> 16" . .	\$	STD								
	<input type="checkbox"/> Long Frame (19" Depth) Set at <input type="checkbox"/> 16" <input type="checkbox"/> 17" <input type="checkbox"/> 18" <input type="checkbox"/> 19" . .	\$	STD								
	<input type="checkbox"/> Positioning Frame Add (")	\$	150								
	<input type="checkbox"/> Ergo Seat Tubing Depth (") *Measurement must be 2.5" longer than your Center of Gravity	\$	200								
3. FOOTREST WIDTH	<input type="checkbox"/> STD (Seat Width Minus 5") <input type="checkbox"/> Taper on Top <input type="checkbox"/> Taper on Bottom	\$	STD								
	<input type="checkbox"/> Custom (") <input type="checkbox"/> Taper on Top <input type="checkbox"/> Taper on Bottom	\$	150								
	<input type="checkbox"/> No Taper (Seat Width Minus)	\$	STD								
FOOT PLATE STYLE	<input type="checkbox"/> Standard single loop with adjust. height & angle. STD Foot Plate	\$	STD								
	<input type="checkbox"/> Single Flip-Back-single loop (no riser avail) with adjust. height & angle. STD Foot Plate K0040	\$	150								
	STD Foot Plate Size Chart <table border="1" style="display: inline-table; margin-left: 20px;"> <thead> <tr> <th>Your Footrest Width</th> <th>Foot Plate Size</th> </tr> </thead> <tbody> <tr> <td>8.5"-10.0"</td> <td>W6.5"xD5"</td> </tr> <tr> <td>10.5"-13.0"</td> <td>W8.5"xD6.5"</td> </tr> <tr> <td>13.5"-17.0"</td> <td>W11"xD6.5"</td> </tr> </tbody> </table>	Your Footrest Width	Foot Plate Size	8.5"-10.0"	W6.5"xD5"	10.5"-13.0"	W8.5"xD6.5"	13.5"-17.0"	W11"xD6.5"		
Your Footrest Width	Foot Plate Size										
8.5"-10.0"	W6.5"xD5"										
10.5"-13.0"	W8.5"xD6.5"										
13.5"-17.0"	W11"xD6.5"										
CUSTOM FOOT PLATE	<input type="checkbox"/> Custom Foot Plate. with adjust. height & angle *Available Solid Plate Only	\$	75								
	<input type="checkbox"/> Custom Tubular Footrest *Measurement must be 2.5" shorter than your Footrest Width	\$	250								
	<input type="checkbox"/> With ABS Foot Plate (\$65 up charge)										
4. FRAME ANGLE	<input type="checkbox"/> 75° <input type="checkbox"/> 80° <input type="checkbox"/> 85° <input type="checkbox"/> 90° to the ground	\$	STD								
	<input type="checkbox"/> Custom (°) to the ground	\$	NCO								

C WHEELS, TIRES & CASTERS, FORKS 1/2

WHEELS																		
Standard Radial Spoke Wheel	<input type="checkbox"/> 24" (540) Only	\$ STD																
Heat-Treated Wheel	<input type="checkbox"/> 24" (540) <input type="checkbox"/> 25" (559) <input type="checkbox"/> 26" (590)	\$ 250																
Cross Knot Laced Spokes	<input type="checkbox"/> 24" (540) <input type="checkbox"/> 25" (559) <input type="checkbox"/> 26" (590)	\$ 250																
Twister Super Strength wheel	<input type="checkbox"/> 24" (540) <input type="checkbox"/> 25" (559) <input type="checkbox"/> 26" (590)	\$ 300																
SUN Fusion 16 Wheel	<input type="checkbox"/> 24" (540) <input type="checkbox"/> 25" (559)	\$ 410																
16 Black Spokes	Hub Color <input type="checkbox"/> Black <input type="checkbox"/> Silver																	
Y-360 Billet Wheels	<input type="checkbox"/> 24" (540) <input type="checkbox"/> 25" (559)	\$ 999																
*Max. Capacity 220Lbs *Camber 0- 2° max *Not for Sports or Rugged use	Style <input type="checkbox"/> Saw Blade <input type="checkbox"/> Hearts(25"only) <input type="checkbox"/> T-Style(25"only)																	
Y-360 Billet Wheels MOD Style	<input type="checkbox"/> 25" (559) Only	\$ 1,499																
*Max. Capacity 220Lbs *Camber 0- 2° max *Not for Sports or Rugged use	Style <input type="checkbox"/> Tribal Sun <input type="checkbox"/> Girls <input type="checkbox"/> Eagle <input type="checkbox"/> Holy Cross <input type="checkbox"/> Hono Specify Powder Coat Color for Insert Only () *Choose from Frame Colors																	
Extra Options for Y-360	<input type="checkbox"/> Spinners Clover (\$650 up charge) <input type="checkbox"/> Powder-Coated Spokes Only () *Choose from Frame Colors (\$150 up charge)																	
X-Core (3 Spokes comp)	<input type="checkbox"/> 25" (559) Only	\$ 743																
*Camber 0- 2° max *Not available with D's Lock *Not available with long tabs	Wheel Color <input type="checkbox"/> Black <input type="checkbox"/> Yellow <input type="checkbox"/> Blue <input type="checkbox"/> Red <input type="checkbox"/> White	\$ 943																
Spinergy Spox	<input type="checkbox"/> 24" (540) <input type="checkbox"/> 25" (559) <input type="checkbox"/> 26" (590)	\$ 695																
18 Spokes	Spoke Color <input type="checkbox"/> Black <input type="checkbox"/> Red <input type="checkbox"/> Yellow <input type="checkbox"/> Blue <input type="checkbox"/> White With Silver Hub With Black Hub With Black Hub With Black Hub With Black Hub																	
	<input type="checkbox"/> Custom Color Spoke Pattern																	
	<table border="1"> <thead> <tr> <th colspan="2"></th> <th>Left Wheel</th> <th>Right Wheel</th> </tr> </thead> <tbody> <tr> <td>Spokes</td> <td>Inside</td> <td></td> <td></td> </tr> <tr> <td>Color</td> <td>Outside</td> <td></td> <td></td> </tr> <tr> <td>Hub Color</td> <td></td> <td><input type="checkbox"/> Black/<input type="checkbox"/> Silver</td> <td><input type="checkbox"/> Black/<input type="checkbox"/> Silver</td> </tr> </tbody> </table>			Left Wheel	Right Wheel	Spokes	Inside			Color	Outside			Hub Color		<input type="checkbox"/> Black/ <input type="checkbox"/> Silver	<input type="checkbox"/> Black/ <input type="checkbox"/> Silver	\$ 795
		Left Wheel	Right Wheel															
Spokes	Inside																	
Color	Outside																	
Hub Color		<input type="checkbox"/> Black/ <input type="checkbox"/> Silver	<input type="checkbox"/> Black/ <input type="checkbox"/> Silver															
Spinergy LX	<input type="checkbox"/> 24" (540) <input type="checkbox"/> 25" (559) <input type="checkbox"/> 26" (590)	\$ 895																
12 Spokes	Spoke Color <input type="checkbox"/> Black <input type="checkbox"/> Red <input type="checkbox"/> Yellow <input type="checkbox"/> Blue With Silver Hub With Black Hub With Black Hub With Black Hub																	
	<input type="checkbox"/> White <input type="checkbox"/> Neon Green <input type="checkbox"/> Pink <input type="checkbox"/> Orange With Black Hub With Black Hub With Black Hub With Black Hub																	
	<input type="checkbox"/> Custom Color Spoke Pattern																	
	<table border="1"> <thead> <tr> <th colspan="2"></th> <th>Left Wheel</th> <th>Right Wheel</th> </tr> </thead> <tbody> <tr> <td>Spokes</td> <td>Inside</td> <td></td> <td></td> </tr> <tr> <td>Color</td> <td>Outside</td> <td></td> <td></td> </tr> <tr> <td>Hub Color</td> <td></td> <td><input type="checkbox"/> Black/<input type="checkbox"/> Silver</td> <td><input type="checkbox"/> Black/<input type="checkbox"/> Silver</td> </tr> </tbody> </table>			Left Wheel	Right Wheel	Spokes	Inside			Color	Outside			Hub Color		<input type="checkbox"/> Black/ <input type="checkbox"/> Silver	<input type="checkbox"/> Black/ <input type="checkbox"/> Silver	\$ 995
		Left Wheel	Right Wheel															
Spokes	Inside																	
Color	Outside																	
Hub Color		<input type="checkbox"/> Black/ <input type="checkbox"/> Silver	<input type="checkbox"/> Black/ <input type="checkbox"/> Silver															
Topolino Cabon Core WX2.5 Wheels	Black Spokes Only <input type="checkbox"/> 24" (540) <input type="checkbox"/> 25" (559) *Max. Capacity 220Lbs	\$ 1,095																
*Not available with D's Lock	Nipples Color <input type="checkbox"/> Red <input type="checkbox"/> Yellow																	
Pro Wheels	<input type="checkbox"/> 24" (540) <input type="checkbox"/> 25" (559)	\$ 825																
w/ Aluminum Color Anodized Handrim *Not available with D's Lock	Spoke & Handrim Color <input type="checkbox"/> Anodized Black <input type="checkbox"/> Anodized Red <input type="checkbox"/> Anodized Blue																	
HANDRIMS																		
Type	<input type="checkbox"/> Standard For 24", 25" or 26" Wheel Anodized Black (*Not available with Pro Wheels)	\$ STD																
	<input type="checkbox"/> Vinyl Coated For 24", 25", 26" Wheel (*Not available with Pro Wheels)	\$ 142																
	<input type="checkbox"/> Natural Fit For 24", 25" Wheel																	
	<input type="checkbox"/> Standard Grip (Not available with short tabs. Not available with Y-360 Billet Wheels, X-Core, Topolino Wheels, Pro Wheels, Mag Wheels)	\$ 295																
	<input type="checkbox"/> Super Grip (Not available with short tabs. Not available with Y-360 Billet Wheels, X-Core, Topolino Wheels, Pro Wheels, Mag Wheels)	\$ 340																
	<input type="checkbox"/> Without Thumb Grip (Not available with Y-360 Billet Wheels, Not available with Pro Wheels, Mag Wheels)	\$ 270																
	<input type="checkbox"/> Natural Fit (LT) For 24", 25" Wheel																	
	<input type="checkbox"/> Standard Grip (Not available with short tabs. Not available with Y-360 Billet Wheels, X-Core, Topolino Wheels, Pro Wheels, Mag Wheels)	\$ 325																
	<input type="checkbox"/> Super Grip (Not available with short tabs. Not available with Y-360 Billet Wheels, X-Core, Topolino Wheels, Pro Wheels, Mag Wheels)	\$ 370																
	<input type="checkbox"/> Without Thumb Grip (Not available with Y-360 Billet Wheels, Not available with Pro Wheels, Mag Wheels)	\$ 300																
	<input type="checkbox"/> The Surge Handrims * Not available with Y-360 Billet Wheels * w / X-Core Wheels required Installation fee (\$30) flat fee	\$ 315																
	<input type="checkbox"/> The Surge Handrims (LT) * Not available with Y-360 Billet Wheels * w / X-Core Wheels required Installation fee (\$30) flat fee	\$ 340																
	<input type="checkbox"/> Spinergy Flex Rim Available only on 24" and 25" Spinergy LX.	\$ 495																
	<input type="checkbox"/> Projections Handrims *Not available with Y-360 Billet Wheels, X-Core, Topolino Wheels, Pro Wheels, Mag Wheels)	\$ CFP																
	*Call For Availability																	
TAB LENGTH	<input type="checkbox"/> Long Tab (STD inside clearance 3/4") * Not available with X-Core Wheels	\$ STD																
	<input type="checkbox"/> Short Tab (Inside clearance 1/2") *Not available with Ultra Grip and Natural Fit Handrim with thumb grip	\$ STD																
	<input type="checkbox"/> Short Tab (Set closest to wheel cut off excess) * Not available with Y-360 wheel, Pro Wheels, X-Core, Pro Wheels	\$ 15																

C WHEELS, TIRES & CASTERS, FORKS 2/2

TIRES			
<input type="checkbox"/> High Pressure Tire	<input type="checkbox"/> 24"x1", <input type="checkbox"/> 25"x1" or <input type="checkbox"/> 26"x1"	Gray Tire with black wall Only	E2211/E2212 \$ STD
<input type="checkbox"/> High Pressure Tire	<input type="checkbox"/> 24"x1", <input type="checkbox"/> 25"x1" or <input type="checkbox"/> 26"x1"	<input type="checkbox"/> Blue <input type="checkbox"/> Red	E2211/E2212 \$ 65
<input type="checkbox"/> Low Pressure Tire	<input type="checkbox"/> 24"x1-3/8" or <input type="checkbox"/> 26"x1-3/8"	Gray Only	E2211/E2212 \$ STD
<input type="checkbox"/> E2211 Schwalbe Marathon Plus High Pressure Tire	<input type="checkbox"/> 24"x1", <input type="checkbox"/> 25"x1" or <input type="checkbox"/> 26"x1"	Black Only	E2211/E2212 \$ 99
<input type="checkbox"/> Solid Tire	<input type="checkbox"/> 24"x1", <input type="checkbox"/> 25"x1" or <input type="checkbox"/> 26"x1"	<input type="checkbox"/> Dark Gray <input type="checkbox"/> Black(\$30up charge)	E2218 \$ 135
<input type="checkbox"/> E2211 Moderate V-Track Knobby Tire	24"x1-3/8" (37-540)	Gray Only	E2211/E2212 \$ 117
<input type="checkbox"/> E2211 Aggressive Knobby Tire	24"x 2" (50-540)	Gray Only	E2211/E2212 \$ 117
<input type="checkbox"/> E2211 Aggressive Knobby Tire	26"x 1.95" (50-559)	Black Only	E2211/E2212 \$ 117
<input type="checkbox"/> E2213 Flat-Free Inserts For 24"x1-3/8" Tires Only			E2211/E2213 \$ 117

CASTERS					
SIZE	TIRE WIDTH	HUB COLOR	TIRE COLOR	DESCRIPTION	
<input type="checkbox"/> 3"	1"	Black Hub	Black Tire Only	Polyeurethane	\$ STD
<input type="checkbox"/> 3"	1"	Plastic Black Hub	Clear Tire Only	Lighted, Polyurethane	\$ 65
<input type="checkbox"/> 3"	1"	Red Hub	Red Tire Only	Polyurethane	\$ STD
<input type="checkbox"/> 3"	1"	Black Hub	Clear Tire Only	Polyurethane	\$ STD
<input type="checkbox"/> 3"	1"	Aluminum Silver Hub	Black Tire Only	Made By Flog Legs	\$ 165
<input type="checkbox"/> 3"	1"	Aluminum Black Hub	Black Tire Only	Made By Flog Legs	\$ 165
<input type="checkbox"/> 3"	1.5"	Aluminum Silver Hub	Black Tire Only	Soft Roll Made By Flog Legs	\$ 165
<input type="checkbox"/> 3"	1.5"	Aluminum Black Hub	Black Tire Only	Soft Roll Made By Flog Legs	\$ 165
<input type="checkbox"/> 4"	1"	Plastic Black Hub	Black Tire Only		\$ STD
<input type="checkbox"/> 4"	1"	Plastic Black Hub	Clear Only	Lighted, Polyurethane	\$ 65
<input type="checkbox"/> 4"	1"	Plastic Black Hub	Black Tire Only	Made By Flog Legs	\$ 125
<input type="checkbox"/> 4"	1"	Aluminum Silver Hub	Black Tire Only	Made By Flog Legs	\$ 165
<input type="checkbox"/> 4"	1"	Aluminum Black Hub	Black Tire Only	Made By Flog Legs	\$ 165
<input type="checkbox"/> 4"	1.5"	Composite Black Hub	Tire <input type="checkbox"/> Black <input type="checkbox"/> Blue <input type="checkbox"/> Red	Soft Roll Made By Flog Legs	\$ 135
<input type="checkbox"/> 4"	1.5"	Aluminum Silver Hub	Tire <input type="checkbox"/> Black <input type="checkbox"/> Blue <input type="checkbox"/> Red	Soft Roll Made By Flog Legs	\$ 165
<input type="checkbox"/> 4"	1.5"	Aluminum Black Hub	Black Tire Only	Soft Roll Made By Flog Legs	\$ 165
<input type="checkbox"/> 5"	1"	Composite Black Hub	Black Tire Only		\$ STD
<input type="checkbox"/> 5"	1"	Plastic Black Hub	Clear Tire Only	Lighted, Polyurethane	\$ 65
<input type="checkbox"/> 5"	1"	Composite Black Hub	Black Tire Only	Made By Flog Legs	\$ 125
<input type="checkbox"/> 5"	1"	Aluminum Silver Hub	Black Tire Only	Made By Flog Legs	\$ 165
<input type="checkbox"/> 5"	1"	Aluminum Black Hub	Black Tire Only	Made By Flog Legs	\$ 165
<input type="checkbox"/> 5"	1.5"	Composite Black Hub	Tire <input type="checkbox"/> Black <input type="checkbox"/> Blue <input type="checkbox"/> Red	Soft Roll Made By Flog Legs	\$ 135
<input type="checkbox"/> 5"	1.5"	Aluminum Silver Hub	Tire <input type="checkbox"/> Black <input type="checkbox"/> Blue <input type="checkbox"/> Red	Soft Roll Made By Flog Legs	\$ 165
<input type="checkbox"/> 5"	1.5"	Aluminum Black Hub	Black Tire Only	Soft Roll Made By Flog Legs	\$ 165

FORKS			
<input type="checkbox"/> STD Aluminum Forks With Suspension Springs	Black Only		E1015 \$ STD
Extra Options for Aluminum Forks	<input type="checkbox"/> Without Suspension Springs		\$ NCO
	<input type="checkbox"/> With Quick Release Axles		K0073 \$ 107
<input type="checkbox"/> Frog Leg Suspension Forks Std 1" Wide (For 3", 4" x 1" width Caster and 5" STD Caster, 5" lighted Caster)	(Not available with Quick Release Axles)	Color <input type="checkbox"/> Anodized Black <input type="checkbox"/> Anodized Silver	E1015 \$ 575
<input type="checkbox"/> Frog Leg Suspension Forks 1.5" Wide (For 3", 4" x 1.5" width Caster and 5" x 1" & 5" x 1.5" Casters)	(Not available with Quick Release Axles)	Color <input type="checkbox"/> Anodized Black <input type="checkbox"/> Anodized Silver	E1015 \$ 575

Sub Total Section C 1/2	\$
Sub Total Section C 2/2	\$
Total Section C	\$

D COMPONENTS

WHEEL LOCKS		
<input type="checkbox"/> Push to Lock / Anodized Black Only		\$ STD
<input type="checkbox"/> NEW Compact Push to Lock / Anodized Black Only <input type="checkbox"/> w/ 2" Extension Handle (\$65up)		\$ 110
<input type="checkbox"/> NEW Compact Scissor Lock / Anodized Black Only		\$ 110
PUSH HANDLES *If you are ordering push handles, You must select the backrest locking mechanism.		
<input type="checkbox"/> Integrated w/Fixed Backrest Height / Anodized Black Only		\$ STD
<input type="checkbox"/> Bolt-on / Anodized Black Only Specify Height from floor -()		\$ 142
<input type="checkbox"/> Bolt-on w/Quick Release / Anodized Black Only Specify Height from floor -()		\$ 190
<input type="checkbox"/> NEW Height Adj. / Anodized Black Only Specify Maximum height from floor -()		\$ 295
NEW ARM RESTS Anodized Black Only,		
<input type="checkbox"/> Fixed Tubular Armrest Adj. Angle and Height Height from seat sling Set at : <input type="checkbox"/> 8" <input type="checkbox"/> 9" <input type="checkbox"/> 10" <input type="checkbox"/> 11" <input type="checkbox"/> 12" E0973		\$ 250
<input type="checkbox"/> Swing Away Tubular Armrest Adj. Angle and Height Height from seat sling Set at : <input type="checkbox"/> 8" <input type="checkbox"/> 9" <input type="checkbox"/> 10" <input type="checkbox"/> 11" <input type="checkbox"/> 12" E0973		\$ 250
<input type="checkbox"/> Flip-Up Armrest <input type="checkbox"/> w/Fixed Tubular Armrest Height from seat sling Set at : <input type="checkbox"/> 8" <input type="checkbox"/> 9" <input type="checkbox"/> 10" <input type="checkbox"/> 11" <input type="checkbox"/> 12" E0973		\$ 250
Adj. Angle <input type="checkbox"/> w/ Swing Away Tubular Armrest Height from seat sling Set at : <input type="checkbox"/> 8" <input type="checkbox"/> 9" <input type="checkbox"/> 10" <input type="checkbox"/> 11" <input type="checkbox"/> 12" E0973		\$ 250
<input type="checkbox"/> Custom Length & Height (\$150 up charge) *Specify Height & Length →		
ANTI-TIPPERS		
<input type="checkbox"/> Anti-Tippers (pair) w/ Quick Release / Anodized Black Only	E0971	\$ 112
SIDE GUARDS		
<input type="checkbox"/> Rigid Side Guards - Black ABS <input type="checkbox"/> Non-Removable <input type="checkbox"/> Removable <input type="checkbox"/> Removable w/Hole (\$10 up charge) Size: <input type="checkbox"/> STD <input type="checkbox"/> Medium <input type="checkbox"/> Cut to Wheel (\$98 up charge) Measurement		\$ 142
<input type="checkbox"/> Rigid Side Guards - Aluminum <input type="checkbox"/> Non-Removable <input type="checkbox"/> Removable Size: <input type="checkbox"/> Medium Only <input type="checkbox"/> Cut to Wheel (\$98 up charge) Measurement Color <input type="checkbox"/> Black (STD) <input type="checkbox"/> Pol. Aluminum (STD) <input type="checkbox"/> Powder Coated () (\$50 up charge) <input type="checkbox"/> Gold Plate (+CFP)		\$ 197
<input type="checkbox"/> PRO-TEX Fender Guards / (Black ABS -Only) <input type="checkbox"/> Cut to Fit Specs <input type="checkbox"/> Do Not Install		\$ 175
<input type="checkbox"/> Fabric Clothing Guards Black Nylon w/Velcro		\$ 78
SEAT CUSHION -*Please see section E for other cushion choices.-		
<input type="checkbox"/> Foam Cushion w/Nylon Black Cover Thickness <input type="checkbox"/> 1" <input type="checkbox"/> 2" <input type="checkbox"/> 3" <input type="checkbox"/> 4"		\$ 78
<input type="checkbox"/> Custom Cushion Cover (Std. Foam Cushion Only) -Select Fabric () (\$90 up charge)		
MISCELLANEOUS		
<input type="checkbox"/> Frame Protectors / Black Leather/Zipper Type		\$ 78
<input type="checkbox"/> K0065 Spoke Protectors / Black Only <input type="checkbox"/> 24" <input type="checkbox"/> 25" <input type="checkbox"/> 26" K0065		\$ 107
<input type="checkbox"/> E0978 Seat Belt w/Auto Buckle (BP) 1.5" Black Belt Only E0978		\$ 69
<input type="checkbox"/> Tie Down Brackets 4pcs.		\$ 210
SPECIALTY PARTS <input type="checkbox"/> Wheelchair Tray Size: <input type="checkbox"/> W14"x D12" <input type="checkbox"/> W16"x D14" <input type="checkbox"/> W18"x D14" Color: <input type="checkbox"/> Raw Alum. <input type="checkbox"/> Black Alum. <input type="checkbox"/> Polish Alum.(\$250 up charge)		\$ 250
UPHOLSTERY CHOICE & COLOR *Positioning Back Available. Please see Section E		
<input type="checkbox"/> Standard Adjustable Ht Backrest Black Only		\$ STD
<input type="checkbox"/> Adjustable Tension Backrest Black Only (*Not available with 8" Backrest Height)		\$ 135
Custom Options <input type="checkbox"/> Fabrics for Fun <input type="checkbox"/> 001 <input type="checkbox"/> 002 <input type="checkbox"/> 003 <input type="checkbox"/> 004 <input type="checkbox"/> 006 <input type="checkbox"/> 010 <input type="checkbox"/> 011 . . . (\$95 up charge) <input type="checkbox"/> For Std. or Adj. Style <input type="checkbox"/> 014 <input type="checkbox"/> 015 <input type="checkbox"/> 016 <input type="checkbox"/> 017 <input type="checkbox"/> 018 <input type="checkbox"/> 020 <input type="checkbox"/> 021 <input type="checkbox"/> 022 <input type="checkbox"/> 023 <input type="checkbox"/> 024 <input type="checkbox"/> 025 <input type="checkbox"/> 026 <input type="checkbox"/> 027 <input type="checkbox"/> 028 <input type="checkbox"/> Backrest Leather Trim (outside panels) (\$77 up charge)		
<input type="checkbox"/> Calf Strap <input type="checkbox"/> Black <input type="checkbox"/> Matching Fabric (\$55 up charge) -Select Fabric() K0038		\$ 24
<input type="checkbox"/> Matching Fabric on Padded Side Guards -Select Fabric ()		\$ 210
Total Section D \$		

E CHAIR OPTIONS 1/2

SEAT CUSHION					
SUPRACOR® WHEELCHAIR CUSHIONS					
Stimulite® Contoured Cushion *Black Upholstery only	<input type="checkbox"/> W14"xD16" (CD1416)	E2603	\$ 525	
	<input type="checkbox"/> W16"xD16" (CD1616)	E2603	\$ 525	
	<input type="checkbox"/> W16"xD18" (CD1618)	E2603	\$ 525	
	<input type="checkbox"/> W18"xD16" (CD1816)	E2603	\$ 525	
	<input type="checkbox"/> W18"xD18" (CD1818)	E2603	\$ 525	
	<input type="checkbox"/> W18"xD20" (CD1820)	E2603	\$ 540	
	<input type="checkbox"/> W20"xD16" (CD2016)	E2603	\$ 540	
	<input type="checkbox"/> W20"xD18" (CD2018)	E2603	\$ 540	
	<input type="checkbox"/> W20"xD20" (CD2020)	E2603	\$ 555	
			<input type="checkbox"/> Extra Sensitive (\$30 up charge)		
		<input type="checkbox"/> Sling Style Bottom (\$45 up charge)			
		<input type="checkbox"/> Custom Size W(") x D(") (-\$ CFP)			
Stimulite® Slimline Cushion *Black Upholstery only	<input type="checkbox"/> W14"xD16" (SM1416)	E2603	\$ 495	
	<input type="checkbox"/> W16"xD16" (SM1616)	E2603	\$ 495	
	<input type="checkbox"/> W16"xD18" (SM1618)	E2603	\$ 495	
	<input type="checkbox"/> W18"xD18" (SM1818)	E2603	\$ 495	
	<input type="checkbox"/> W18"xD20" (SM1820)	E2603	\$ 495	
	<input type="checkbox"/> W20"xD16" (SM2016)	E2603	\$ 510	
	<input type="checkbox"/> W20"xD18" (SM2018)	E2603	\$ 510	
	<input type="checkbox"/> W20"xD20" (SM2020)	E2603	\$ 510	
			<input type="checkbox"/> Extra Sensitive (\$30 up charge)		
			<input type="checkbox"/> Sling Style Bottom (\$45 up charge)		
		<input type="checkbox"/> Custom Size W(") x D(") (-\$ CFP)			
Stimulite® Corbee Pediatric *Black Upholstery only	<input type="checkbox"/> W10"xD10" (PD1010)	E2603	\$ 450	
	<input type="checkbox"/> W12"xD12" (PD1212)	E2603	\$ 450	
	<input type="checkbox"/> W14"xD14" (PD1414)	E2603	\$ 450	
		<input type="checkbox"/> Extra Sensitive (\$30 up charge)			
		<input type="checkbox"/> Sling Style Bottom (\$45 up charge)			
		<input type="checkbox"/> Custom Size W(") x D(") (-\$ CFP)			
ROHO WHEELCHAIR CUSHIONS					
Choose Size	<input type="checkbox"/> 4" HIGH PROFILE® QUADTRO SELECT® CUSHION		*Black Upholstery	E2622-2623	
	<input type="checkbox"/> W12"xD12"	<input type="checkbox"/> W12"xD13"	<input type="checkbox"/> W13"xD13"	<input type="checkbox"/> W13"xD15"	
	<input type="checkbox"/> W15"xD16"	<input type="checkbox"/> W15"xD18"	<input type="checkbox"/> W16"xD15"	<input type="checkbox"/> W16"xD16"	
	<input type="checkbox"/> W18"xD16"	<input type="checkbox"/> W18"xD18"	<input type="checkbox"/> W18"xD20"	<input type="checkbox"/> W18"xD22"	
	<input type="checkbox"/> W20"xD22"	<input type="checkbox"/> W22"xD18"	<input type="checkbox"/> W22"xD20"	<input type="checkbox"/> W22"xD22"	
		<input type="checkbox"/> Custom Size W(") x D(") (+\$85)			
Choose Size	<input type="checkbox"/> 3" MID PROFILE® QUADTRO SELECT® CUSHION		*Black Upholstery only	E2622-2623	
	<input type="checkbox"/> W15"xD15"	<input type="checkbox"/> W15"xD16"	<input type="checkbox"/> W16"xD16"	<input type="checkbox"/> W16"xD18"	
		<input type="checkbox"/> Custom Size W(") x D(") (+\$85)			
Choose Size	<input type="checkbox"/> 2" LOW PROFILE® QUADTRO SELECT® CUSHION		*Black Upholstery only	E2622-2623	
	<input type="checkbox"/> W12"xD12"	<input type="checkbox"/> W12"xD13"	<input type="checkbox"/> W13"xD13"	<input type="checkbox"/> W13"xD15"	
	<input type="checkbox"/> W15"xD16"	<input type="checkbox"/> W15"xD18"	<input type="checkbox"/> W16"xD15"	<input type="checkbox"/> W16"xD16"	
	<input type="checkbox"/> W18"xD16"	<input type="checkbox"/> W18"xD18"	<input type="checkbox"/> W18"xD20"	<input type="checkbox"/> W20"xD16"	
	<input type="checkbox"/> W20"xD16"	<input type="checkbox"/> W20"xD18"	<input type="checkbox"/> W20"xD20"	<input type="checkbox"/> W20"xD20"	
		<input type="checkbox"/> Custom Size W(") x D(") (+\$85)			
Choose Size	<input type="checkbox"/> 2" NEXUS SPIRIT® CUSHION		*Black Upholstery only	E2622	
	<input type="checkbox"/> W14"xD14"	<input type="checkbox"/> W14"xD16"	<input type="checkbox"/> W15"xD15"	<input type="checkbox"/> W16"xD16"	
		<input type="checkbox"/> W16"xD16"	<input type="checkbox"/> W16"xD18"	<input type="checkbox"/> W17"xD17"	
		<input type="checkbox"/> W18"xD18"	<input type="checkbox"/> W18"xD16"		
		* Custom Size Not Available			
STAR CUSHIONS					
Galaxy Cushion *Black Upholstery only	<input type="checkbox"/> W14"xD14" (GXY 1414-2)	<input type="checkbox"/> W14"xD16" (GXY 1416-2)	Choose Zoning Options ⇒ <input type="checkbox"/> Standard - Dual Valve <input type="checkbox"/> Dual Valve - Front to Back <input type="checkbox"/> Four Valve <input type="checkbox"/> Simple - Single Valve <input type="checkbox"/> Four Valve - Enhanced <input type="checkbox"/> Four Valve - Front to Back	E2624	
	<input type="checkbox"/> W16"xD14" (GXY 1614-2)	<input type="checkbox"/> W16"xD16" (GXY 1616-2)		\$ 498	
	<input type="checkbox"/> W16"xD18" (GXY 1618-2)	<input type="checkbox"/> W18"xD16" (GXY 1816-2)			
	<input type="checkbox"/> W18"xD18" (GXY 1818-2)	<input type="checkbox"/> W18"xD20" (GXY 1820-2)			
	<input type="checkbox"/> W20"xD16" (GXY 2016-2)	<input type="checkbox"/> W20"xD18" (GXY 2018-2)			
	<input type="checkbox"/> W20"xD20" (GXY 2020-2)				
THE CURVE CUSHION *Black Upholstery only	<input type="checkbox"/> W10"xD10"	<input type="checkbox"/> W10"xD11"	<input type="checkbox"/> W10"xD11"	<input type="checkbox"/> W10"xD12"	
	<input type="checkbox"/> W12"xD13"	<input type="checkbox"/> W12"xD14"	<input type="checkbox"/> W13"xD11"	<input type="checkbox"/> W13"xD12"	
	<input type="checkbox"/> W14"xD14"	<input type="checkbox"/> W14"xD15"	<input type="checkbox"/> W14"xD16"	<input type="checkbox"/> W15"xD14"	
	<input type="checkbox"/> W16"xD14"	<input type="checkbox"/> W16"xD15"	<input type="checkbox"/> W16"xD16"	<input type="checkbox"/> W16"xD17"	
	<input type="checkbox"/> W17"xD17"	<input type="checkbox"/> W17"xD18"	<input type="checkbox"/> W18"xD16"	<input type="checkbox"/> W18"xD17"	
	<input type="checkbox"/> W12"xD12"	<input type="checkbox"/> W13"xD14"	<input type="checkbox"/> W15"xD15"	<input type="checkbox"/> W15"xD16"	
	<input type="checkbox"/> W16"xD18"	<input type="checkbox"/> W17"xD16"	<input type="checkbox"/> W18"xD18"		
NOTE					

E CHAIR OPTIONS 2/2

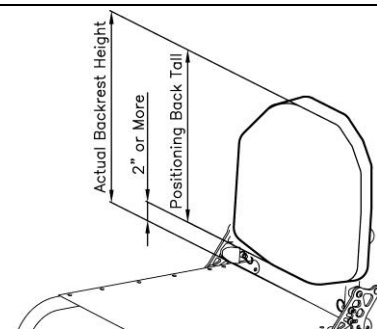
POSITIONING BACK		
<p>*Note : Actual height of the backrest will increase 2" or more.</p> 		
<p>ADI CARBON BACKREST (Support Contour-ACTIVE 2.5") *Not Available with Welded Side Guards</p> <p>Mounting Hardware: <input type="checkbox"/> 2 Point Pro <input type="checkbox"/> Quick Release</p>		
Height	<input type="checkbox"/> LOW (10" Tall) *Backrest Height requires 12" or more *Available 13"-19" width Width (") E2613 \$ 745 <input type="checkbox"/> Medium (13" Tall) *Backrest Height requires 15" or more *Available 13"-19" width Width (") E2613 \$ 815 <input type="checkbox"/> Standard (16" Tall) *Backrest Height requires 18" or more *Available 13"-19" width Width (") E2613 \$ 880 <input type="checkbox"/> Custom Size (" Tall) x (" width) E2613 \$ CFP	
<p>ADI ALUMINUM BACKREST (Support Contour-ACTIVE 2.5") *Not Available with Welded Side Guards</p> <p>Mounting Hardware: <input type="checkbox"/> 2 Point Pro <input type="checkbox"/> Quick Release</p>		
Height	<input type="checkbox"/> LOW (10" Tall) *Backrest Height requires 12" or more *Available 10"-20" width Width (") E2613 \$ 610 <input type="checkbox"/> Medium (13" Tall) *Backrest Height requires 15" or more *Available 12"-20" width Width (") E2613 \$ 625 <input type="checkbox"/> Standard (16" Tall) *Backrest Height requires 18" or more *Available 14"-20" width Width (") E2613 \$ 640 <input type="checkbox"/> Tall (18" Tall) *Backrest Height requires 20" or more *Available 16"-20" width Width (") E2613 \$ 655 <input type="checkbox"/> X-Tall (20" Tall) *Backrest Height requires 22" or more *Available 16"-20" width Width (") E2613 \$ 670 <input type="checkbox"/> Custom Size (" Tall) x (" width) E2613 \$ CFP	
<p>ADI ALUMINUM BACKREST (Support Contour-DEEP 4") *Not Available with Welded Side Guards *Not Available with Lateral Supports</p> <p>Mounting Hardware: <input type="checkbox"/> 2 Point Pro <input type="checkbox"/> Quick Release</p>		
Height	<input type="checkbox"/> LOW (10" Tall) *Backrest Height requires 12" or more *Available 10"-20" width Width (") E2615 \$ 710 <input type="checkbox"/> Medium (13" Tall) *Backrest Height requires 15" or more *Available 12"-20" width Width (") E2615 \$ 725 <input type="checkbox"/> Standard (16" Tall) *Backrest Height requires 18" or more *Available 14"-20" width Width (") E2615 \$ 740 <input type="checkbox"/> Tall (18" Tall) *Backrest Height requires 20" or more *Available 16"-20" width Width (") E2615 \$ 755 <input type="checkbox"/> X-Tall (20" Tall) *Backrest Height requires 22" or more *Available 16"-20" width Width (") E2615 \$ 770 <input type="checkbox"/> Custom Size (" Tall) x (" width) E2615 \$ CFP	
<p>ADI LATERAL SUPPORTS (Lateral Supports are compatible with only active 2.5" ADI positioning back.)</p> <p><input type="checkbox"/> Stationary Pad Pad Size <input type="checkbox"/> Small (3" H x 3" D) <input type="checkbox"/> Medium(3" H x 4" D) <input type="checkbox"/> Large(4.5" H x 4.5" D) <input type="checkbox"/> Large(4" H x 6" D)</p> <p> <input type="checkbox"/> Pair \$ 320</p> <p> <input type="checkbox"/> Left side only or <input type="checkbox"/> Right side only \$ 160</p> <p><input type="checkbox"/> Swing-Out Pad Size <input type="checkbox"/> Small (3" H x 3" D) <input type="checkbox"/> Medium(3" H x 4" D) <input type="checkbox"/> Large(4.5" H x 4.5" D) <input type="checkbox"/> Large(4" H x 6" D)</p> <p> <input type="checkbox"/> Pair \$ 520</p> <p> <input type="checkbox"/> Left side only or <input type="checkbox"/> Right side only \$ 260</p>		
OTHER		
<input type="checkbox"/> ADI Transfer Board <input type="checkbox"/> 21" (ADV21) <input type="checkbox"/> 24" (ADV24) <input type="checkbox"/> 29" \$ 62		
<input type="checkbox"/> ADI Push and Transfer Gloves Leather (one size fits) \$ 60		
<input type="checkbox"/> ADI Carbon Solid Seat (Wide: 18" Max, Depth: 20") *Colours Side Guards Not Available with ADI Carbon Solid Seat \$ 625		
With / <input type="checkbox"/> ADI Folding Carbon Side Guard \$ 400		
With / <input type="checkbox"/> ADI Fixed Carbon Side Guard \$ 375		
<p>VARILITE® Seating Systems Available</p> <p style="text-align: right;">Please visit for all options. www.varilite.com</p>		CFP
NOTE		
Sub Total Section E 1/2		\$
Sub Total Section E 2/2		\$
Total Section E		\$

F SPECIAL PARTS COLORS (Please allow an additional 1-2 weeks delivery)

PARTS COLORS						
Powder-Coated	Gloss Black	Twilight Flake	Yellow	Magenta	Fire Engine Red	White
	Candy Blue	Candy Purple	Candy Green	Candy Red	Candy Raspberry	Cobalt Blue
	Matte Gray	Matte Purple	Matte Blue	Matte Green	Matte Black	Matte Red
	Neon Red	Neon Green	Orange Sparkle	Mellon Yellow	Gun Smoke Silver	Pigeon Blue
	Granny Sparkle Green	Sparkle Sky Blue	Vermilion	Reed Green	Blue Lilac	
Special Colors	Polished Aluminum					
	24 karat Gold Plated *Please allow an additional 4 weeks delivery					

Please Choose the Color for each Part

*Parts not selected will be black color. (Suspension Spring: Silver Color)
 *Minimum 3 parts selected per order.

*PC=Powder-Coated

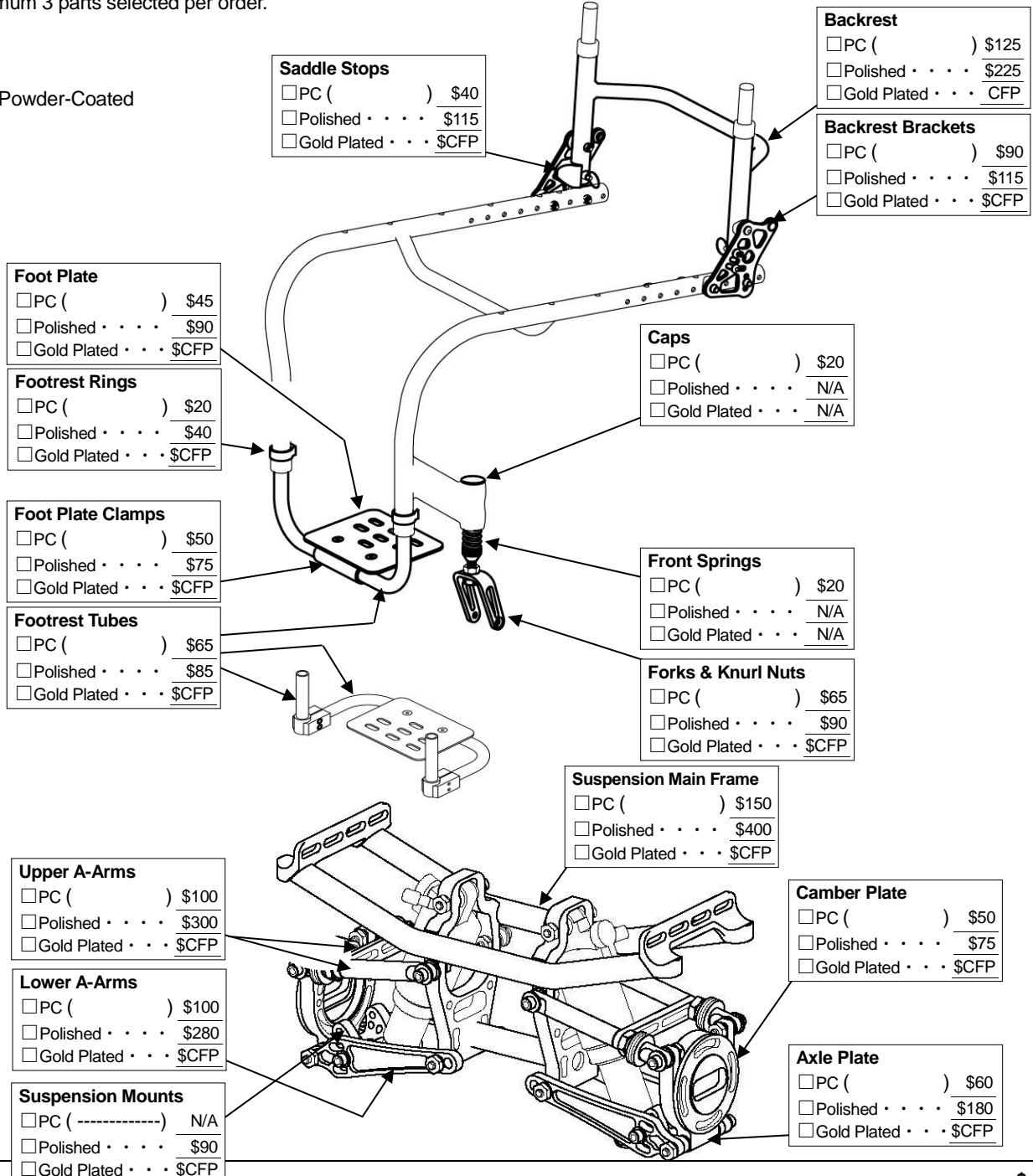

Total Section F \$

1. SEAT WIDTH

Measure from outside of seat tube to the outside of the opposite seat tube.

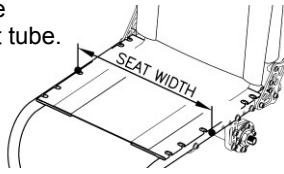

2. SEAT DEPTH

Measure from at the front bottom of backrest tube to the front edge of seat sling.

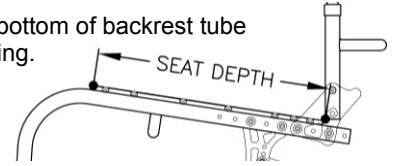

3. FOOTREST WIDTH

Measure from inside of front frame tube to inside of opposite front frame tube.

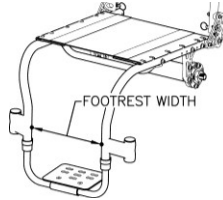

4. FRAME ANGLE

Measure angle frame front to floor.

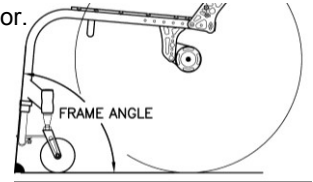

5. BACKREST HEIGHT

Measure from top of back post to seat sling at front bottom of backrest tube.

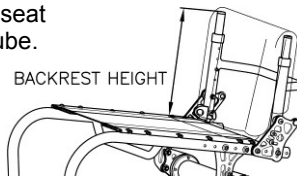

6. BACKREST ANGLE

Measure angle from front of back post to floor.

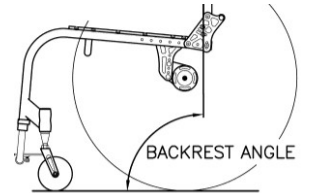

7. FRONT SEAT HEIGHT

Measure from floor to top of seat sling at front edge.

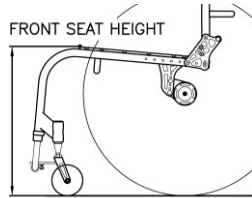

8. REAR SEAT HEIGHT

Measure from floor to top of seat sling at front bottom of backrest tube.

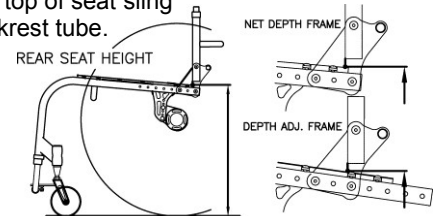

9. CENTER OF GRAVITY

Measure from center of back tube at the folding pivot to the center of the rear axle.

(If welding backrest is selected, Measure from center of back tube at the seat tube to the center of the rear axle.)

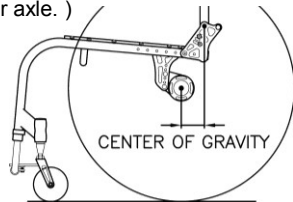

10. CAMBER ANGLE

Measure angle from wheel to vertical at floor.

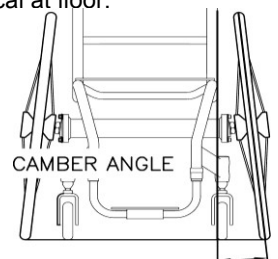

11. FRONT OF SEAT SLING TO FOOTREST

ADULT CHAIR

Measure from top of seat sling at front edge to top of foot plate at front edge.

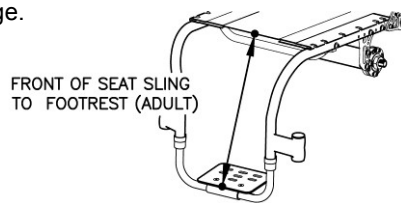

PEDIATRIC CHAIR

Measure vertical from top of seat sling at front edge to top of foot plate.



12. INSIDE WHEEL CLEARANCE

Measure from outside of seat back tube to inside of rear tire.

(If side guards are selected, measure from outside of side guards to inside of rear tire.)

