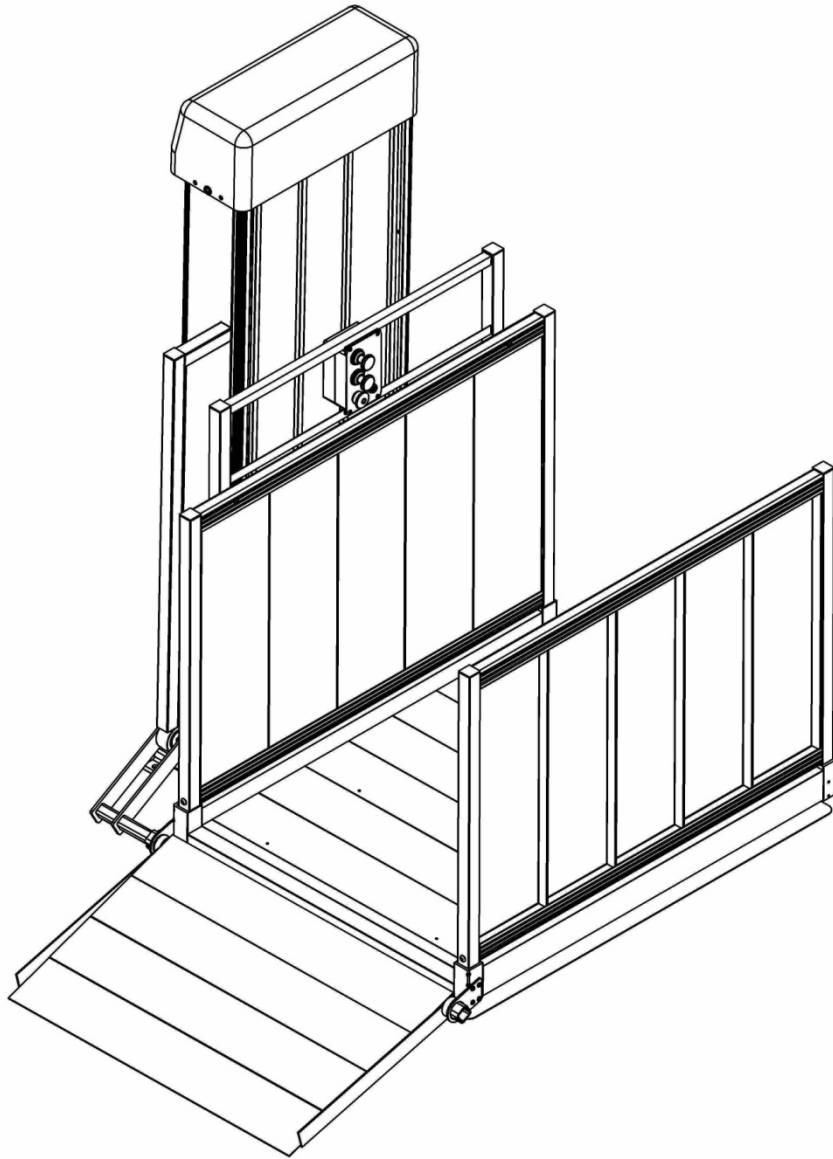


PASSPORT™ Vertical Platform Lift (VPL)

User Manual for P52S and P72S Models



Manufactured in the USA

INTRODUCTION

Congratulations and thank you for purchasing the PASSPORT™ Residential Vertical Platform Lift (VPL). At Homecare Products, Inc., we are proud to offer this select line of assistance equipment designed to provide you years of trouble-free performance.


This User Manual provides important operation, maintenance, service and safety instructions. It is important that you read and understand this User Manual before installing and or using the VPL. Refer to the VPL's Installation Manual and User Manual as needed. If you have additional questions, your dealer contact information can be found in Section 3 of this manual.


Unless indicated otherwise, this manual applies to the P52S and P72S models.

Table of Contents

Section 1	----	Symbols, Safety and Warnings
Section 2	----	Maintenance and Service
Section 3	----	Dealer Contact Information
Section 4	----	Labeling
Section 5	----	Optional Equipment Notice
Section 6	----	Optional Equipment - Wireless Remote
Section 7	----	Optional Equipment - Top Landing Gate
Section 8	-----	Top Landing Gate Optional Equipment - Pathway Connector Kit
Section 9	-----	Top Landing Gate Optional Equipment - Deck Connector Kit
Section 10	----	Optional Equipment - Platform Safety Rail
Section 11	----	Optional Equipment - Platform Safety Pan Weather Guard
Section 12	----	Optional Equipment - Interlock
Section 13	----	Optional Equipment - Call/Send Control
Section 14	-----	Call/Send Control Optional Equipment - Call/Send Control Mounting Kit
Section 15	----	Features
Section 16	----	Operating Instructions
Section 17	----	Emergency Operation
Section 18	----	Specifications
Section 19	----	Troubleshooting
Section 20	----	Main Components Drawing
Section 21	----	Warranty

[SECTION 1](#) - SYMBOLS, SAFETY AND WARNINGS

 This **WARNING** symbol may appear in various colors and in conjunction with other symbols. The warning symbol indicates a failure to obey that safety warning could result in property damage, damage to equipment, serious personal injury or death. The word **WARNING** may appear, in capital letters, bold font, in lieu of the symbol where symbol usage is impractical.

 This is the NOTE symbol. This symbol may appear in various colors and in conjunction with other symbols. This indicates a failure to obey all notes could result in improper operation, less than optimum VPL performance, and at the sole discretion of the VPL manufacturer, may void your warranty. The word NOTE may appear, in capital letters, in lieu of the symbol where symbol usage is impractical.

⚠ SAFETY WARNINGS: The safety warnings throughout this manual are for the protection of people and property. Failure by any operator to obey all VPL safety warnings will result in a waiver of all liabilities, loss of your warranty and could result in equipment damage and or failure, injury to property, risk of serious bodily injury, and or death.

- ⚠ Read the User Manual in its entirety. Understand and learn the location and function of all the features, safety devices, and labels before operating the VPL.
 - ⚠ Do not exceed the weight capacity of 750 pounds (340 Kg.) for this VPL.
 - ⚠ Do not use VPL for anything other than its intended purpose of personal residential use for lifting of individuals and personal mobility devices.
 - ⚠ Keep all body parts away from moving components and within the platform guards during VPL operation.
 - ⚠ The Platform Safety Rail option must be installed if the VPL is used by a standing occupant.
 - ⚠ Never play on or near the VPL.
 - ⚠ Turn off power and engage the brake on all mobility devices prior to cycling the VPL.
 - ⚠ Remove ice, snow, leaves and other potentially unsafe materials from VPL and landings before each use.
 - ⚠ Inspect VPL for damaged, missing, or inoperable parts before each use. Never use a damaged or unstable VPL.
 - ⚠ Periodically check all fasteners and verify all nuts, bolts, screws and other fasteners are undamaged and secure. Do not attempt to repair or modify the VPL. Only qualified technicians may service the VPL. Contact your dealer to schedule any needed inspections, repairs or service.
 - ⚠ Observe and avoid all pinch points.
 - ⚠ Whenever not actively using the VPL, turn keyed power switch to “OFF” position and remove key.
 - ⚠ Always unplug VPL from electrical outlet before cleaning. Only plug VPL back in when area around VPL is dry.
 - ⚠ Never operate VPL with damaged electrical wires, cords, or plugs.
 - ⚠ The AC electrical plug on this VPL is grounded and intended to be used only with a properly grounded AC outlet. Do not remove ground pin from AC power cord. If ground pin is broken or missing, immediately contact your dealer to schedule repairs.
 - ⚠ Stop using VPL and immediately and contact your dealer for inspection and service if any defect is suspected.
 - ⚠ Do not tamper with or attempt to modify the VPL or any of its systems.
 - ⚠ Use VPL only with a qualified helper, if required.
 - ⚠ Do not use the VPL to support, attach, or hang planters, baskets, lights, adornments, decorations, clothing, fabrics or other ornamentals or furnishings.
 - ⚠ Components inside the tower must be serviced by a qualified technician. Contact you dealer to schedule any needed inspections, repairs or service.
 - ⚠ Periodic inspections by a qualified technician are highly recommended to help prevent unsafe conditions.
 - ⚠ A visual inspection of all bolts and nuts to be sure that they are securely in place must be done by the VPL owner. If there are any missing or damaged fasteners or other components, they must be replaced by a qualified technician. Contact your dealer to schedule any needed inspections, repairs or service.
 - ⚠ The VPL’s electrical cord must be routed and situated in a manner that poses no hazards. Do not lay power cords on or across electrically conductive materials, such as metals and always route power cords in such a manner so no one can trip over them and they are not exposed to risk of accidental or incidental damage.
 - ⚠ Before and during VPL operation, ensure all hair, jewelry, shirts, ties, shoe laces and all other forms of clothing and other personal ornamentation are-not and do-not hang up on anything that may create a hazard.
-
- 👤⚠ The VPL is designed exclusively for personal residential use to provide safe access to and from your home. Using this VPL for anything other than its intended purpose will void the warranty.
 - 👤⚠ Do not use the VPL to support, attach, or hang planters, baskets, lights, adornments, decorations, clothing, fabrics or other ornamentals or furnishings.
 - 👤⚠ Correct installation, proper use, and following of instructions and obeying safety warnings and of the VPL are necessary for safe operation.
 - 👤⚠ If service outside the guidelines of this manual is required, please contact your dealer for additional information, for replacement labels and manuals, or to schedule any needed inspections, repairs or service.
 - 👤⚠ VPL must be anchored to a concrete slab before operating the VPL while it is occupied. Using the VPL while occupied before installation can be hazardous.
 - 👤⚠ The VPL comes with various product safety labels. Do not remove safety labels or devices. If any labels are missing, damaged or become illegible they must be replaced. An illegible decal will fail to alert individuals on or around the VPL of a procedure or potential hazard resulting in an unsafe operating condition which could lead to severe injury or fatality of occupant and or others. Refer to section 4 for images of the labels that should be found on the VPL. Maintaining all labels and manuals in legible condition is required by the VPL owner and is essential for safe VPL operation. Contact your dealer for additional information, for replacement labels and manuals, or to schedule any needed inspections, repairs or service.



Illumination: A minimum illumination at the landing edge of the floor with the landing door open of not less than 50 lx (5 fc).

Illumination of at least 100 lx shall be provided:

- (a) at the drive unit in the location where periodic maintenance and inspection are required;
- (b) on the carriage at the seat or platform surface and at the operating devices; and
- (c) at the floor level of landing/loading points.

- For proper warranty coverage, contact your dealer.
- Keep all protective coverings in place, unless servicing the VPL.
- The VPL warranty is not transferable.
- Attempting to tamper with or modify any portion of the VPL will void your warranty.
- Except as described elsewhere in this manual, maintenance must only be performed by qualified technicians. Contact your dealer to schedule any needed inspections, repairs or service.
- Caustics, high alkaline detergents and solutions should not be used to clean aluminum.

SECTION 2 - MAINTENANCE AND SERVICE

1. Except as described elsewhere in this manual, maintenance must be performed only by qualified technicians. Contact your dealer with questions or to schedule any needed inspections, repairs or service.
2. Annual inspections by a qualified technician are highly recommended to help prevent unsafe conditions and operation. Contact your dealer with questions or for additional information, to request replacement labels or manuals, or to schedule any needed inspections, repairs or service.
3. A visual inspection of all bolts and nuts to be sure that they are securely in place must be done by the user before using. If there are any missing or damaged fasteners or other components, they need to be replaced by a qualified technician to ensure continued safe operation. Contact your dealer with questions for additional information, to request replacement labels or manuals, or to schedule any needed inspections, repairs or service, or call our Customer Service line at 1-800-451-1903, or visit us on the internet at www.ezaccess.com.
 - There are two holes in the tower used for mounting the guard ramp activating bar which do not have fasteners in them. This is normal since the guard ramp activating bar can be mounted on either side.
4. Keep the VPL platform free of debris. Sweeping to clear these areas regularly enough to prevent debris accumulation is required. Wiping with a damp cloth should be sufficient for additional surface cleaning. If needed, a soft brush with mild soap and water can be used on the platform and guard ramp surfaces.
 - Alkaline based detergents should not be used to clean your VPL.
5. If the platform and guard ramp surface are covered with frost, ice and or snow, remove frost, ice and or snow before using the VPL.
 - Calcium chloride is often used to deice and prevent ice from forming on roads. Used properly, this may be useful to help rid or keep your VPL platform free of frost, ice and snow.
 - If using a deicing or ice preventing agent, such as Calcium chloride, always check that the platform is free of ice before using it. Calcium chloride may not always be effective in removing frost, ice and or snow.
 - If the VPL was cleaned with soap, rinse all soap from VPL and let VPL dry before using.
 - Use extra caution while on the VPL platform and guard ramp surfaces are icy or wet.
 - If cleaning with water, turn off VPL and unplug the AC power before cleaning.
6. Periodically check and ensure that the safety pan under the platform moves freely up and down and is not damaged. This is the built in safety device designed to detect obstructions under the platform and stop platform downward motion.
 - Do not operate VPL if the safety pan is malfunctioning. Contact your dealer immediately, or call our Technical Support line at 1-800-332-1381, or visit us on the internet at www.ezaccess.com.

SECTION 3 - DEALER CONTACT INFORMATION

FIRST POINT OF CONTACT SHOULD BE YOUR DEALER.

DEALER NAME: _____

ADDRESS: _____

TELEPHONE: _____

INTERNET: _____

If you need additional assistance, please or call one of the numbers below.

Customer Service: 1-800-451-1903 VPL Technical Support: 1-800-332-1381 Internet: www.ezaccess.com.

SECTION 4 - LABELING

 The illustrations in this section represent labels affixed to the VPL. If any labels are missing or otherwise not legible, please contact your dealer for replacements, or call our Customer Service line at 1-800-451-1903, or visit us on the internet at www.ezaccess.com.

FIG. 4.1 Represents the Serial Number label.

This label contains important information you will need when talking with your dealer about VPL options, service and other questions you may have.

To assure you the best possible service, please be sure to have the Model and Serial Numbers for your VPL available when you call for technical assistance.

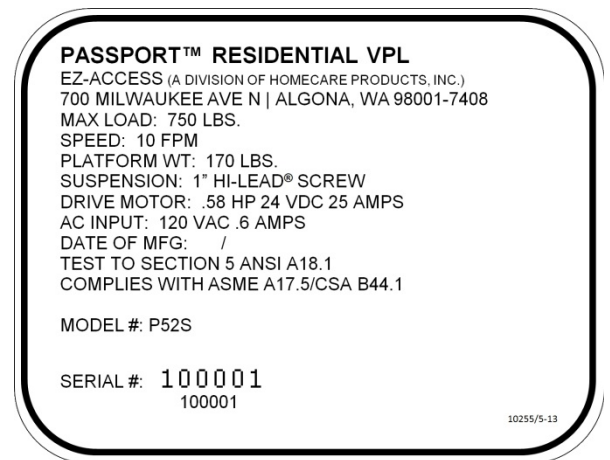


FIG. 4.1

The image below is an undersized depiction of the actual VPL Standard Safety Label. Your Standard Safety Label will be much larger.



FIG. 4.2

Use the image below to locate your VPL labels. Labels are located on the tower side.

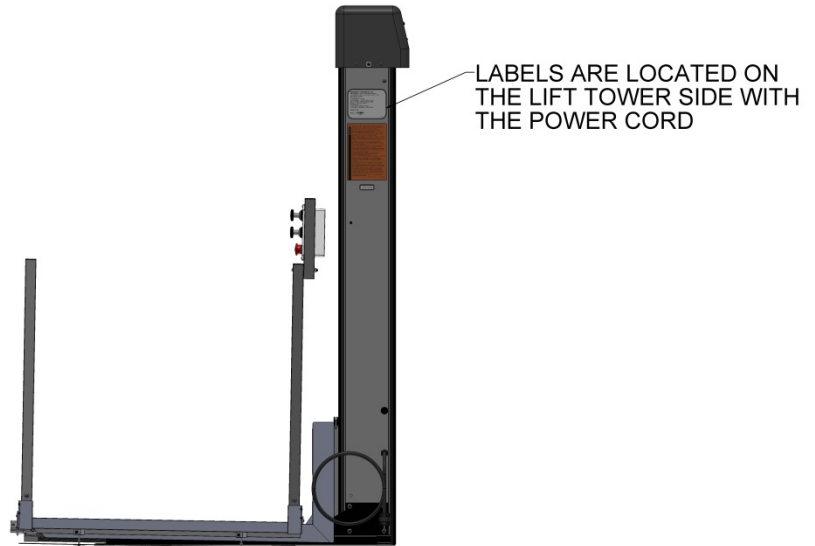


FIG. 4.3

SECTION 5 – OPTIONAL EQUIPMENT NOTICE

VPL Options are sold separately. Options do not come with a standard VPL. If you would like additional information on any options, please contact your dealer, call our Customer Service line at 1-800-451-1903 or visit us on the www.ezaccess.com.

SECTION 6 - OPTIONAL EQUIPMENT - WIRELESS REMOTE



FIG. 6.1

The Wireless Remote transmitter FOB (or keyfob) allows operating the VPL from remote locations, i.e., inside your house or vehicle. To provide you with all the versatility and coverage you need, the Wireless Remote option and the Call/Send Control option can be used together.

Need another FOB or a replacement? Additional FOB transmitters are available. Multiple FOB transmitters are available. For additional information, please contact your dealer, call our Customer Service line at 1-800-451-1903 or visit us on the internet at www.ezaccess.com.



Do not allow unauthorized persons to use the VPL Wireless Remote transmitter FOB.

Always confirm the area around the VPL is clear of people, animals, and debris before activating the Wireless Remote transmitter

PROGRAMING YOUR WIRELESS REMOTE TRANSMITTER(S) AND RECEIVER

Your wireless remote comes pre-programmed for your VPL. Replacement and additional wireless remotes may need programming. Below, and included with each new/replacement wireless remote, is the procedure for wireless remote programming.

PROGRAMMING INSTRUCTIONS:

Each keyfob transmits its own unique internal address whenever a button on the keyfob is pressed. The receiver needs to be programmed to respond to the keyfob transmitter it operates with. The following steps configure the receiver to operate with a keyfob transmitter.

Up to twelve keyfob transmitters can be programmed to one receiver. Please read the entire programming procedure before starting. Prior to programming the receiver, verify the receiver is connected to the input power and the long-range antenna is installed into the connector on the receiver. When the receiver enters program mode, all previously programmed transmitter addresses will be erased.

1. Locate the pushbutton labeled "PROGRAM" on the receiver. Press and hold this button until the red LED next to the program button illuminates (approximately 5 seconds). The receiver is now in the transmitter program mode. Release the blue button. At this point all previously programmed transmitter addresses are erased from the receiver's memory.
2. Press either button on the keyfob transmitter and verify the red LED on the receiver extinguishes and then illuminates (blinks once). Release the button.
3. Repeat previous step for additional key fob transmitters that will operate with this particular receiver. The red LED on the receiver will extinguish and illuminate one time for the first transmitter being programmed, twice for the second, three times for the third, four times for the fourth etc. The receiver will not respond to transmitters that have already been programmed.
4. If no transmitter switch is pressed for 5 seconds, the receiver will return to normal operation. The red LED on the receiver will blink rapidly then extinguish. The receiver is now ready for use.

 The receiver remembers its programming even if power is disconnected.

SECTION 7 - OPTIONAL EQUIPMENT – TOP LANDING GATE

The Top Landing Gate, illustrated in below, is designed with your safety in mind. The Top Landing Gate is used to control the access between the VPL and your upper landing, porch or deck and may be required by your local building codes. Be sure to check with your dealer regarding applicable building code requirements.



FIG. 7.1

Left is an illustration of the “PINCH POINT” warning label affixed to your Top Landing Gate. VPL owner is responsible for maintaining this label in a legible condition. If you need replacement labels, please contact your dealer.

PINCH POINTS

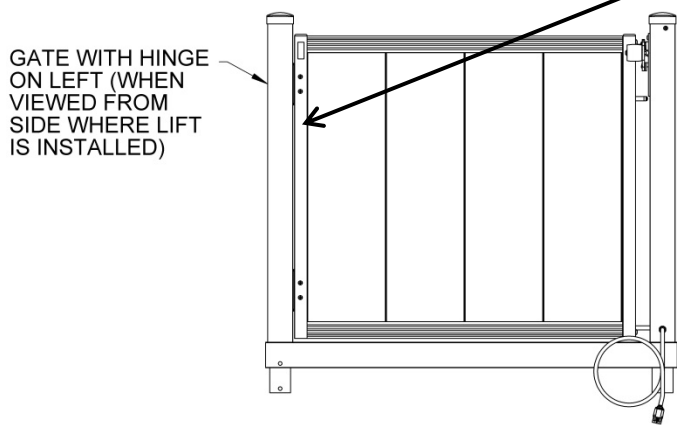


FIG. 7.2

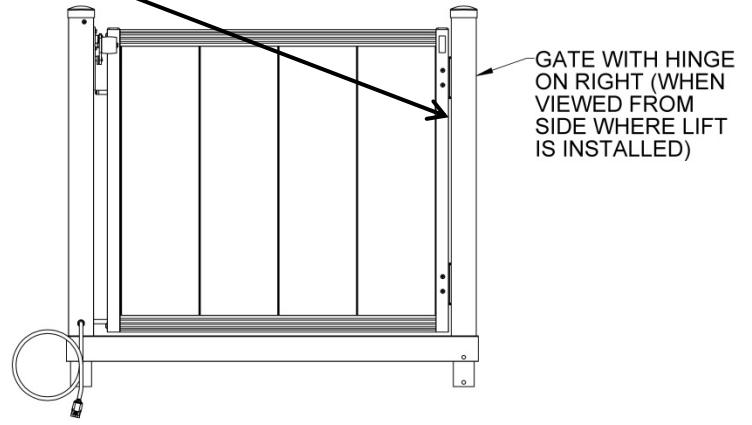


FIG. 7.3

👉 The Top Landing Gate comes in configurations with the hinges on either the Left or Right.

SECTION 8 - TOP LANDING GATE OPTIONAL EQUIPMENT - PATHWAY CONNECTOR KIT

Illustrated on the right is the Pathway Connector Kit. This option is designed to quickly and easily connect a Top Landing Gate to a Pathway platform.

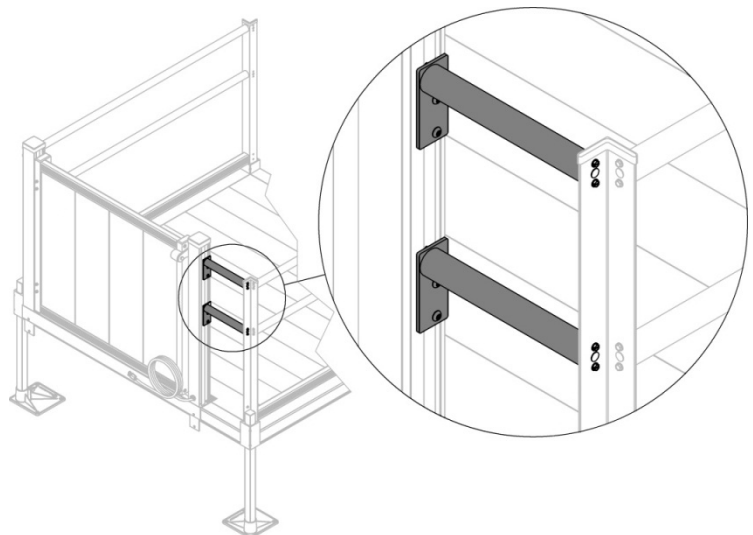


FIG. 8.1

SECTION 9 - TOP LANDING GATE OPTIONAL EQUIPMENT - DECK CONNECTOR KIT

FIG. 9.1 illustrates the Deck Connector Kit, which is designed to quickly and easily connect a gate post to a deck.

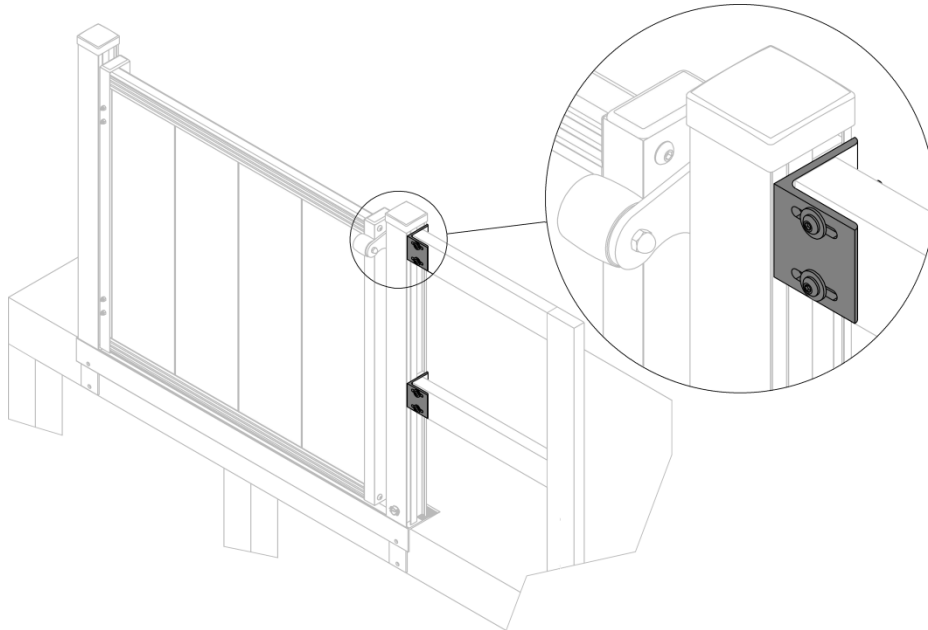
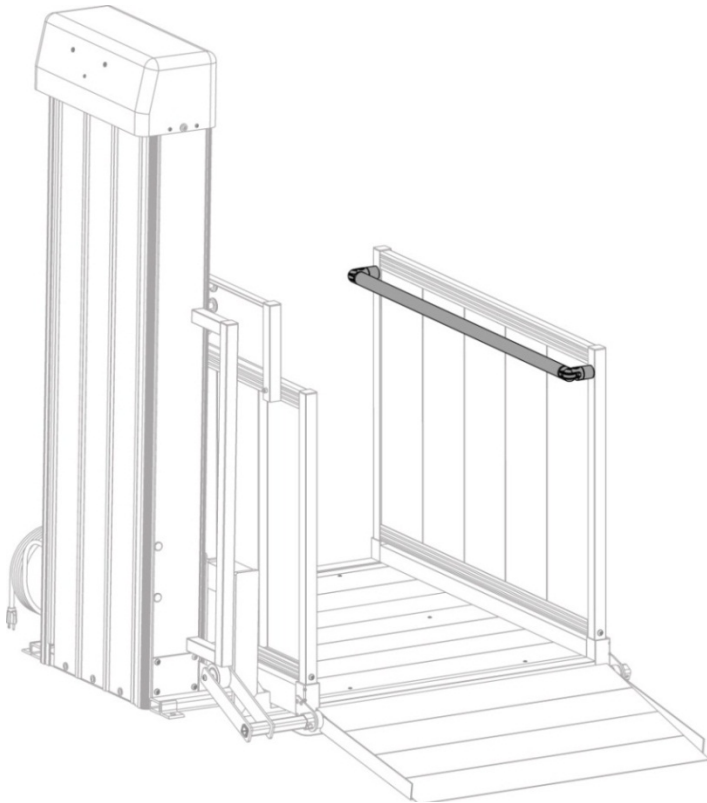



FIG. 9.1

SECTION 10 - OPTIONAL EQUIPMENT - PLATFORM SAFETY RAIL



 The Platform Safety Rail, pictured at left, option is required to be used by anyone standing on the VPL.

The Platform Safety Rail is designed exclusively to provide additional personal stability for those standing on the VPL.

FIG. 10.1

SECTION 11 - OPTIONAL EQUIPMENT - PLATFORM SAFETY PAN WEATHER GUARD

The Platform Safety Pan Weather Guard, at right, helps keep the Safety Pan free of debris.

The Platform Safety Pan Weather Guard option is made of durable materials and installs quickly by simply clipping onto the Safety Pan.

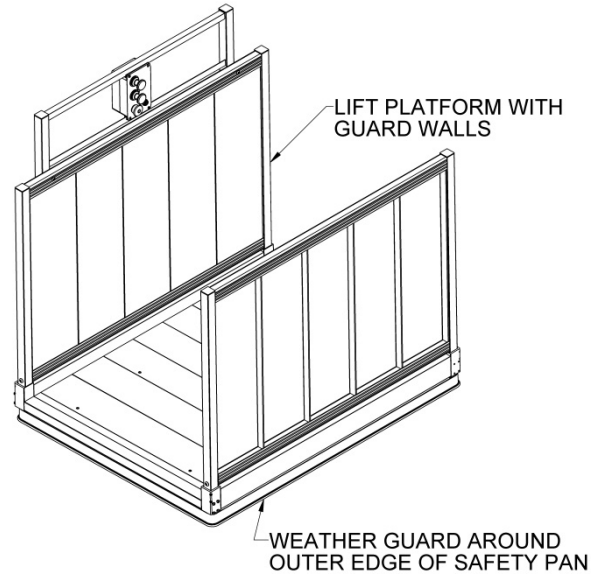


FIG. 11.1

SECTION 12 - OPTIONAL EQUIPMENT - INTERLOCK

👉 Direction of door swing must be specified at the time you place your order for the optional Interlock. Determine whether the door handle is on the left or right when looking at the door from the VPL platform before ordering. FIG. 12.1 and FIG. 12.2 illustrate the Interlock.

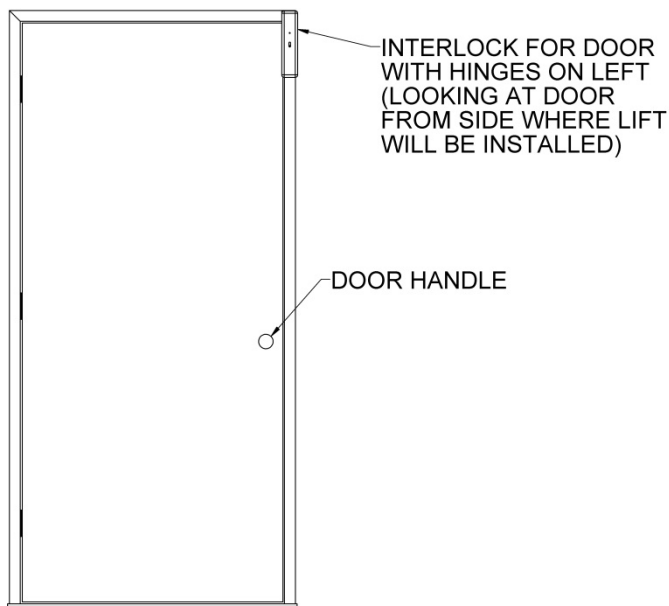


FIG. 12.1

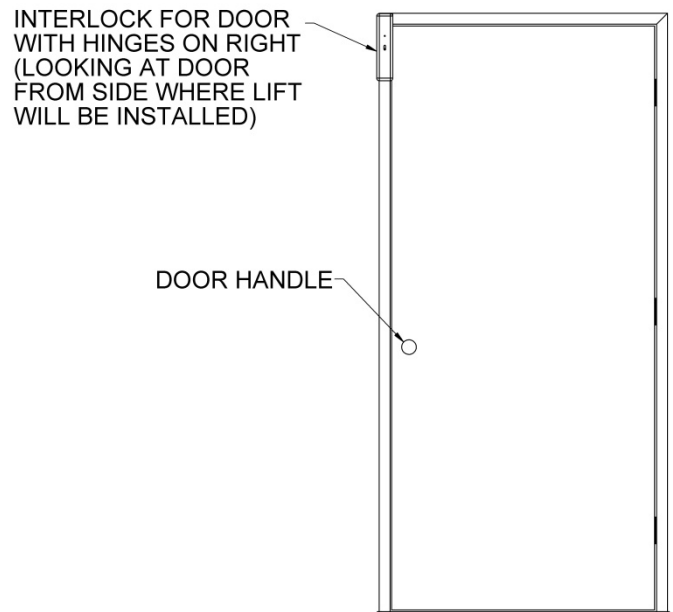


FIG. 12.2

SECTION 13 - OPTIONAL EQUIPMENT - CALL/SEND CONTROL

Multiple Call/Send Controls can be used with the VPL. This allows you to “call” the platform from multiple locations. (FIG. 13.1)

From the bottom of the stairs, or landing; simply press the DOWN button and the platform descends.

From the top landing, deck, or porch; simply press the UP button and the platform ascends.

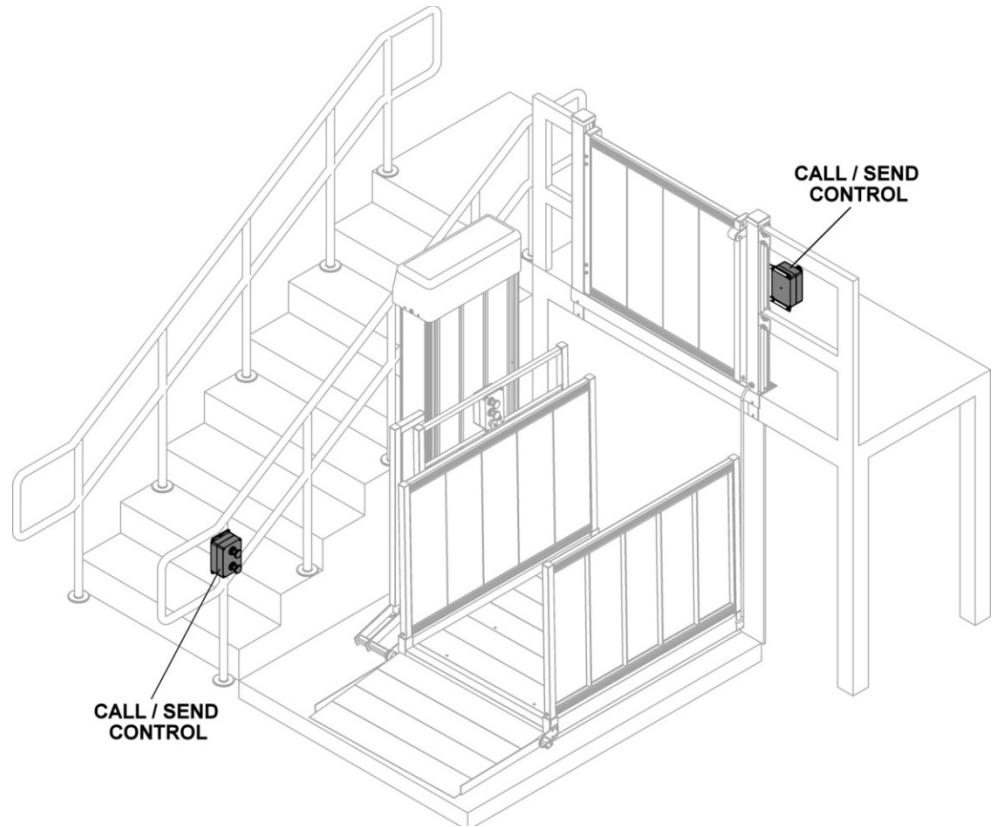


FIG. 13.1

SECTION 14 - OPTIONAL EQUIPMENT - CALL/SEND CONTROL MOUNTING KIT

The Call/Send Control Mounting Kit (FIG. 14.1) option is required to quickly attach your Call/Send Control to your Top Landing Gate post. Multiple Call/Send Controls can be used on the VPL.

👉 The Call/Send Control Mounting Kit can only be installed on the post opposite the hinge. Please contact your dealer if you have any questions or need additional assistance, or call our Customer Service line at 1-800-451-1903 or visit us on the internet at www.ezaccess.com.

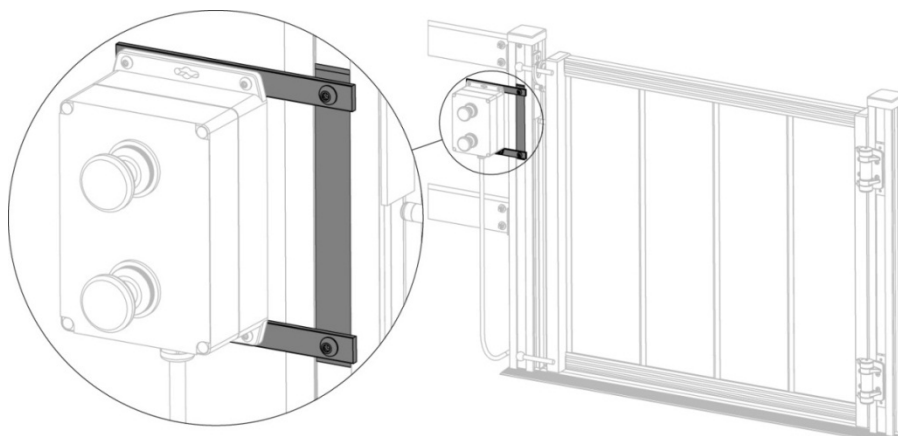


FIG. 14.1

SECTION 15 - FEATURES

DESCRIPTION OF FEATURES

1. Power

- a. The VPL operates on 24 volts DC power supplied by two 12VDC, 12AH (amp hour) batteries. The batteries are charged by a built in "smart charger." Household power (120VAC) is used to operate the charger and is supplied by an outdoor rated 12' power cord. AC power requirements are low, less than ½ amp at 120VAC.
 - ✎ The AC power cord must be connected to a grounded and polarized receptacle.
- b. In the event of a power failure, the VPL is designed to operate approximately 20 cycles on battery power before recharging the batteries is required.
 - ✎ One "cycle" is the VPL moving up-and-down once or down-and-up once.
- c. The batteries require approximately 6 hours to fully charge if totally discharged.
 - ✎ VPL cycles and recharge times are highly dependent on outside temperatures and loads. Low temperatures decrease battery performance and increase charging time.

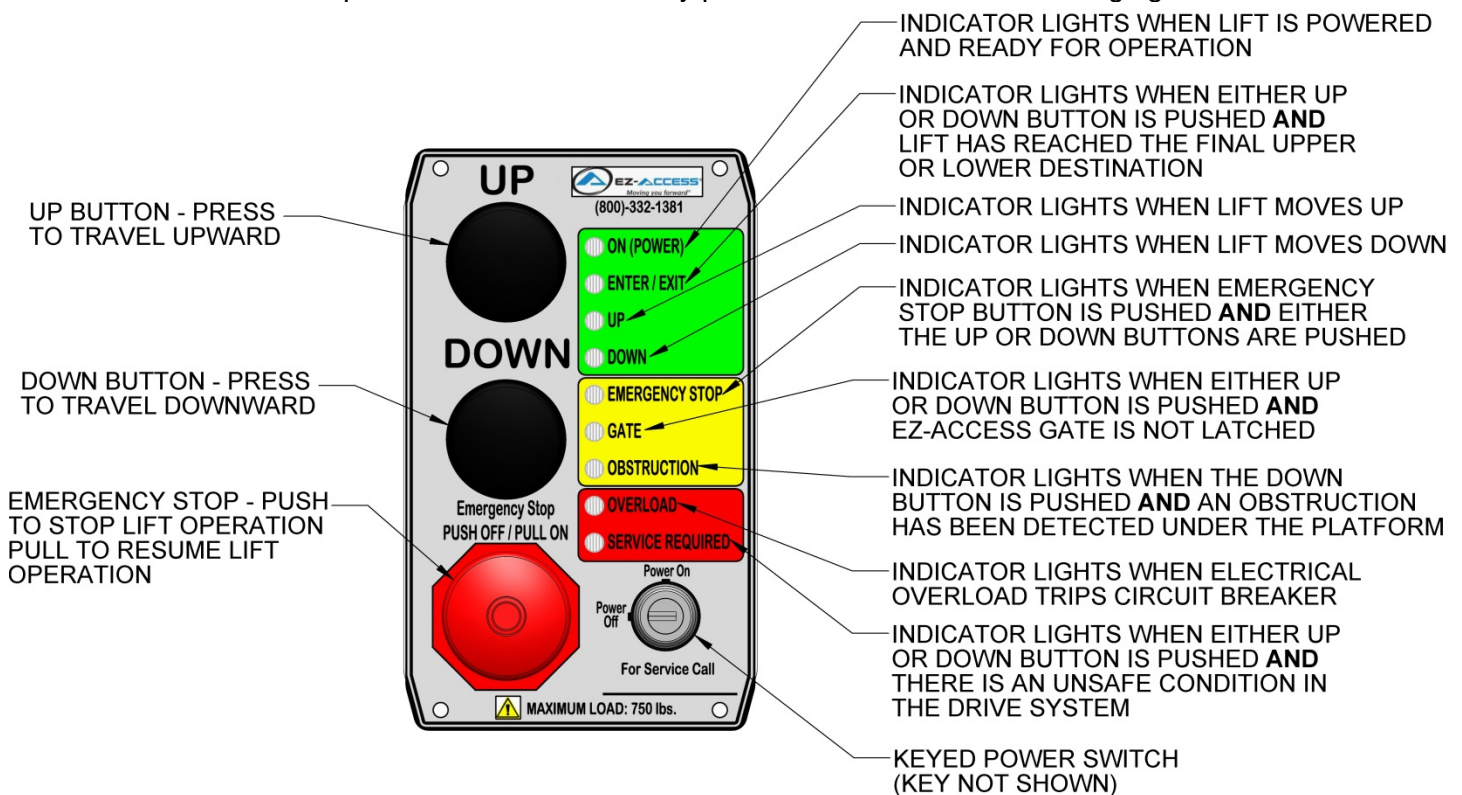


FIG. 15.1
(VPL Operator Control Panel Features)

2. Control Panel

- a. The VPL Operator Control Panel incorporates operational controls as well as function indicator lights. Control functions and features are as follows:
- b. Keyed Power Switch: When turned to the Power On position, the keyed power switch permits VPL operation. When turned to the Power Off position the VPL will not ascend or descend.
- c. The key is removable in both the On and Off positions. If AC power is disconnected from the VPL, leaving the key in the On position will discharge the batteries over about 7 days. The batteries will charge with the key switch in either the On or Off position provided the unit is plugged into AC power.
 - ⚠ Removing the key from the keyed power switch does not disconnect power to the battery charger. The only way to disconnect power to the battery charger is to unplug the VPL from the AC outlet.

d. Up and Down Buttons: The force needed to operate these push buttons is minimal. The VPL platform will travel upward by pressing and holding the Up button in. The VPL platform will travel downward by pressing and holding the Down button in. The VPL will stop moving if a button is not pressed in continually.



It is normal for most of the indicator lights not to illuminate unless either the Up or Down buttons are pressed.

e. Emergency Stop Button: Pressing the Emergency Stop button will remove power ONLY to the motor controls. This will stop VPL from moving up or down. The Emergency Stop Button must be pulled back out to reset for continued operation.



To disconnect power to the battery charger you must unplug the VPL from the AC outlet.

3. Indicator lights

a. The control panel also features a series of bright blue LED indicator lights. These lights are designed to indicate normal operation as well as alert the user to potential problems. The blue LED indicator lights are set into green, yellow and red backgrounds on the control panel.

- Lights in the green background indicate normal operation modes.
- Lights in the yellow background indicate conditions which may be corrected by the user.
- Lights in the red background may require repair by a qualified technician.

The VPL will not operate if any of the lights in the yellow or red fields are illuminated.

b. Blue LED indicator lights in the GREEN background:

- ON (POWER) indicates the keyed power switch is turned to the On position. This verifies the unit is powered for operation.
- UP and DOWN: Indicates when either the Up or Down button is pressed. These indicate the up or down portions of the controls are activated.
- ENTER/EXIT: Indicates the platform has reached either the lower or upper landing position.



If the unit does not stop at the correct height and the ENTER/EXIT indicator light is on, the VPL's travel limit switches require inspection by a qualified technician.

c. Blue LED indicator lights in the YELLOW background:

- EMERGENCY STOP: Indicates when either the Up or Down button is pressed and the Emergency Stop button has been pushed in. The VPL will not operate in this condition. Pulling the emergency stop button back out will clear the condition and allow VPL operation to continue.
- TOP LANDING GATE: Indicates the Up or Down buttons are pushed and Top Landing Gate is open or not latched. The VPL will not operate in this condition. Closing and latching the Top Landing Gate will clear the condition and allow VPL operation to continue.



If a Top Landing Gate is not included in the installation, this indicator light will not function.

- OBSTRUCTION: Indicates the Down button is pushed and an object is detected underneath the platform. In this condition the unit can only operate in the upward direction. Removing the object will clear the condition and allow downward travel to proceed.

d. Blue LED indicator lights in the RED background:






- OVERLOAD: Indicates motor is drawing excessive current and causing the automatic circuit breaker to trip. The automatic breaker will reset after a few minutes. This indicates an abnormal mechanical or electrical condition. If the problem persists, service by a qualified technician is required.
- SERVICE REQUIRED: Lights if either the Up or Down button is pushed and unit has detected a potentially unsafe condition in the drive system. The VPL can only be operated downward in this condition.






Service is required! Call our VPL Technical Support line at 1-800-332-1381.



4. Guard Ramp
 - a. The standard VPL is supplied with a 24" Guard Ramp which can be assembled on either end of the platform allowing access to the VPL from either side. The Guard Ramp operation is automatic. When the VPL rises, the ramp will fold upward providing a safety measure to help prevent accidental travel off the platform while the VPL is moving.
5. Obstruction Detection
 - a. The VPL is supplied with a Safety Pan which is designed to detect an object or obstruction under the platform and stop downward travel when it comes into contact with the Safety Pan. The VPL will still be operational in the upward direction, but the object or obstruction must be cleared to resume downward travel.
6. Emergency Crank
 - a. In the event of a loss of AC power and the batteries have been fully discharged, the VPL may be operated up or down using a manual hand crank. This crank is attached inside the power head cover. As an alternate, a 5/16" hex driver bit on a powered drill can be used to drive the unit up or down. Refer to Section 17 for additional information on the emergency hand crank before using.

SECTION 16 - OPERATING INSTRUCTIONS

1. Read, understand and observe all safety warnings, notes and recommendations throughout this manual.
 -  Do not exceed the VPL's weight capacity of 750 Lbs.
 -  Use VPL with a qualified helper if required.
 -  Do not use VPL for anything other than lifting people and mobility equipment.
 -  Do not operate VPL if it appears damaged.
 -  Never tamper with or attempt to bypass any control sensors or switches. Doing so can result in creating a dangerous situation and will void your warranty.
2. UPWARD TRAVEL:
 - a. Be sure to have a straight, direct path on to the Guard Ramp and Platform.
 - b. Move far enough onto the center of the Platform to allow the Guard Ramp to fold upward without contacting the mobility device.
 - c. Ensure the mobility device and all body parts are completely on the Platform and within the Guard Walls and off of the Guard Ramp.
 - d. Verify no part of the mobility device, body parts, or other items extend beyond the platform.
 - e. Once properly situated on the Platform, turn off power and ensure the brakes are properly set on the mobility device. (Contact manufacturer of your particular mobility device for assistance).
 - f. Rotate the keyed power switch to Power On position. The blue LED indicator light in the GREEN background should now be illuminated.
 - If you want to travel up, press and hold the UP button. The VPL will operate in the upward direction and the UP indicator light will illuminate.
 - g. Continue pressing the up button until the VPL stops automatically at the upper landing. The ENTER/EXIT indicator LED light should illuminate at this time. Release the Up button.








- h. Verify the platform and the top landing levels are within 1/2" of each other.
 -  If the platform and the top landing levels are not within 1/2" of each other, do not attempt to exit the VPL at this time. Raise or lower the VPL until the top landing levels are not within 1/2" of each other before exiting the platform. If the problem persists, contact your dealer to schedule any needed inspections, repairs or service.
 -  If desired, you can now turn the VPL keyed power switch key to the Power Off position prior to exiting
- i. Turn the power back on to your mobility device, release the mobility device brakes and travel off the Platform onto the upper landing.
 -  If your installation includes the optional Top Landing Gate: Once the Platform has reached the upper landing, the Top Landing Gate will automatically unlatch, allowing the gate to open. The Top Landing Gate is spring loaded and will close by itself once you have passed through.

3. DOWNWARD TRAVEL:

- a. If the platform is in the upper landing position the optional Top Landing Gate should swing open by pulling on it. If the Top Landing Gate does not swing open freely this could be an indication that the VPL platform may not be at the required height.
 -  The platform must be properly positioned at the upper landing height before the VPL gate can be operated.
 -  Do not attempt to release the Top Landing Gate latching mechanism manually.
- b. Open the Top Landing Gate and carefully travel onto the platform. Travel far enough that the mobility device and all body parts are completely on the VPL platform and the Top Landing Gate will close fully and latch.
- c. Turn off power and ensure the brakes are securely set on the mobility device. (Contact manufacturer of your particular mobility device for assistance).
- d. Rotate the keyed power switch to Power On position. The blue LED indicator light in the GREEN background should now be illuminated.
- e. Press and hold the DOWN button. The VPL will begin moving in the downward direction and the DOWN indicator light will be illuminated.
- f. Continue pressing the DOWN button until the VPL stops automatically at the lower landing. The ENTER/EXIT indicator LED light will now illuminate. Release the DOWN button.
- g. Verify the guard ramp has folded to the down position and is resting on the lower landing surface.
- h. Turn the power back on to your mobility device, release the mobility device brakes (contact the manufacturer of your particular mobility device for assistance) and travel off the Platform onto the lower landing.

4. OPTIONAL CALL/SEND CONTROL

- a. The remote call is an option. Unless you ordered this as an option, it is not included with a standard VPL. This optional device features remote UP and DOWN buttons.

-  The VPL can be operated in either direction regardless of where the Call/Send Control is located.
-  The keyed power switch on the Control Panel must be in the Power On position to operate the optional VPL with the Call/Send Control.
-  Do not lay cords on electrically conductive materials, such as metals.
-  Do not pull on cables.
-  Route cords so no one can trip over or be entangled in them.
-  Route cords so they are not exposed to risk of damage.
-  Remote calls must be mounted in accordance with applicable codes and in safe locations.

CALL/SEND CONTROL

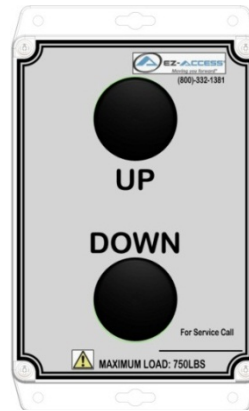








FIG. 16.1

SECTION 17 - EMERGENCY OPERATION

EMERGENCY OPERATION

1. A speed handle wrench (hand crank) and a 5/16" socket are included with the VPL to allow the platform to be moved up and or down in the event of power loss to the VPL motor. The crank is stored inside the cover of the power head.
2. To use the crank, first turn the keyed power switch to the Off position.
3. Unplug the VPL from AC power to avoid accidental starting and potential injury.
 -  Failure to unplug the VPL from AC power, as described, could result in serious injury or death.
 -  Do not pull on power cables.
 -  Route cords so no one can trip over or be entangled in them
 -  Route power cords so they are not exposed to the risk of damage.
 -  The power cable must be plugged into grounded outlets only.
4. Remove the power head cover from the top of the VPL tower by removing the bolts on both sides of the cover (FIG. 17.1).
5. Disconnect the white ground wire from the battery terminal (FIG. 17.2).
6. Remove the crank from inside the power head cover.
7. Place the 5/16" socket onto the drive of the motor and crank to move the VPL. Cranking clockwise (CW) when facing the hex drive end of the motor will raise the platform and cranking counter clockwise (CCW) will lower the platform (FIG. 17.3).
 -  It takes 28 turns to move the VPL platform 1". For faster movement of the VPL platform, a battery or corded power drill with the correct socket may be used instead of the hand crank to drive the motor shaft.

8. If the VPL is occupied at the time of failure, allow the passenger to safely exit prior to determining the possible cause.
9. Place the hand crank back inside the power head cover and secure the cover with the two bolts removed in Step 4 above.
 - ✋ Always keep the hand crank inside the power head cover so it is available during emergency situations.
10. If unit has failed due to power loss, do not operate until a qualified technician has serviced the VPL. Contact your dealer to schedule any needed inspections, repairs or service.

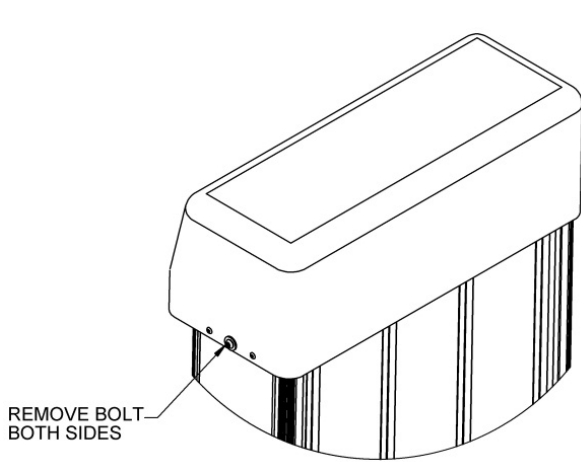


FIG. 17.1

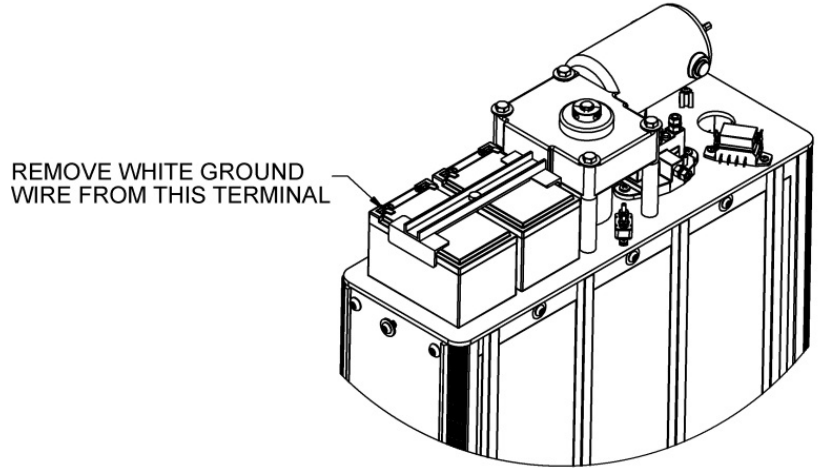


FIG. 17.2

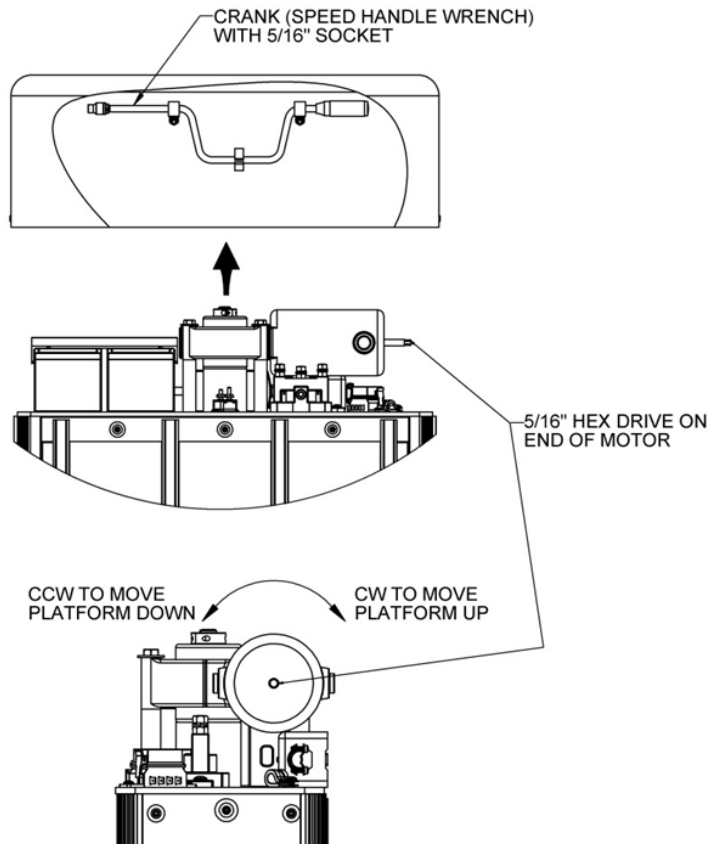


FIG. 17.3

SECTION 18 - SPECIFICATIONS

Models

	P52S	P72S	P52T	P72T
Tower Height with Legs:	76-1/8"	96-1/8"	76-1/8"	96-1/8"
Tower Width with Legs:	33-3/8"	33-3/8"	33-3/8"	33-3/8"
Height at Max. Travel:	97-9/16"	117.75"	97-9/16"	117.75"
Load Capacity:	750 Lbs.		750 Lbs.	
Net Weight:	380 Lbs.	395 Lbs.		
Motor:	.58 HP 24VDC			
Control Voltage:	12 VDC			
Battery Charger:	2 AMP			
AC Power Requirement:	120 VAC @ .5 Amps			
Platform Size:	50.75" x 36" Usable		59.75" x 36" Usable	
Emergency Operation:	Manual hand crank			
Drive Screw Lubrication:	Chevron Ulti-plex [®] Synthetic Grease EP, NLGI Grade 1.5			

TABLE 18.1

AC POWER CONNECTION



FIG. 18.1

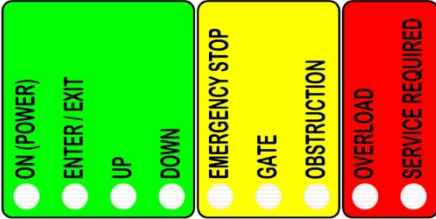
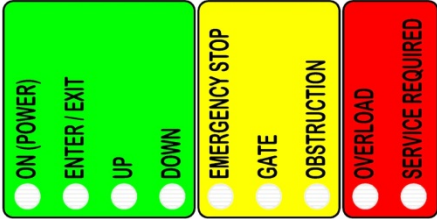
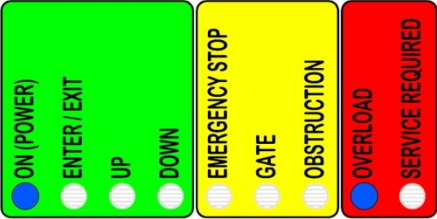


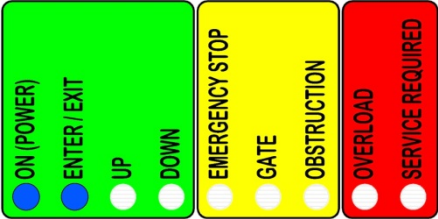
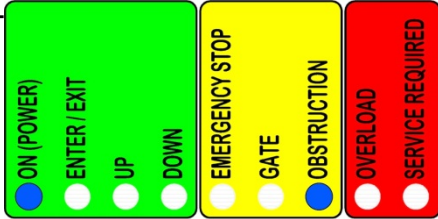
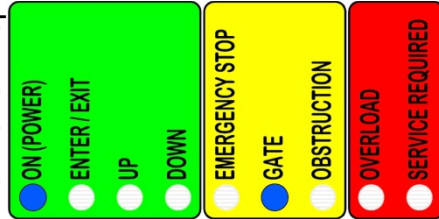
FIG. 18.2



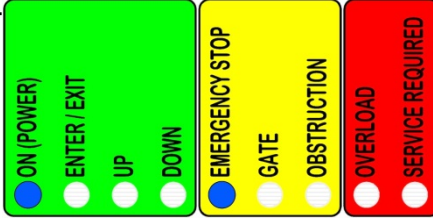


FIG. 18.3

SECTION 19 - TROUBLESHOOTING

<p>Control Panel Display:</p> 	<p>Button Pressed :</p> <p>UP or DOWN</p>	<p>Symptom: VPL will not operate and power indicator light on the Control Panel does not illuminate when the keyed power switch is turned to the Power On position.</p>	<p>Potential Cause: 1) Batteries have discharged.</p>	<p>Solution: See "Batteries Discharged."</p>	<p>Comments:</p>
<p>Control Panel Display:</p> 	<p>Button Pressed :</p> <p>UP or DOWN</p>	<p>Symptom: VPL will not operate and power indicator light on the Control Panel does not illuminate when the keyed power switch is turned to the Power On position.</p>	<p>Potential Cause: 2) Control panel power fuse blown.</p>	<p>Solution: Remove the Power Head Cover and locate fuse #1 (FIG. 19.1). If the fuse has blown the indicator light on fuse should illuminate when the keyed power switch is in the Power On position. Replace the fuse with a 5 amp.</p>	<p>Comments: The fuses supplied with the unit are equipped with LED indicator lights which illuminate when the fuse is blown.</p>
<p>Control Panel Display:</p> 	<p>Button Pressed:</p> <p>UP or DOWN</p>	<p>Symptom: VPL will not operate. Power indicator light on control panel illuminates when keyed power switch is in the Power On position and the overload indicator illuminates.</p>	<p>Potential Cause: Auto reset breaker has tripped.</p>	<p>Solution: Allow unit to sit a few minutes. The auto reset breaker should automatically reset and the unit should be operational. If the breaker does not reset or continues tripping after resetting a number of times, service by a qualified technician is required. Consult your dealer for service information.</p>	<p>Comments: Under normal operating conditions the automatically resetting breaker (which supplies power to the VPL motor) should not trip. Operating the VPL in an overloaded weight condition, mechanical or electrical issues can cause the breaker to trip. The breaker will reset by itself within 1-5 minutes.</p>

<p>Control Panel Display:</p> 	<p>Button Pressed:</p> <p>UP</p>	<p>Symptom:</p> <p>VPL stops above or below upper landing level and Enter/Exit indicator light illuminates.</p>	<p>Potential Cause:</p> <p>Upper limit switch trigger ramp is out of adjustment</p>	<p>Solution:</p> <p>Adjust upper limit trigger ramp as needed. Refer to the VPL Installation Manual. This adjustment should only be made by a qualified technician. Consult your dealer for service related information.</p>	<p>Comments:</p> <p>Up and Down travel is controlled by limit switch trigger ramps which trip a series of switches incorporated into the carriage. The downward limit is set at the lowest position and the upper limit set at maximum possible height at the factory. The upper limit is then adjusted to the required upper landing height during installation.</p>
<p>Control Panel Display:</p> 	<p>Button Pressed:</p> <p>DOWN</p>	<p>Symptom:</p> <p>VPL stops during downward travel and the Obstruction light illuminates when down button is pushed.</p>	<p>Potential Cause:</p> <p>Object underneath platform contacting safety pan and stopping downward travel</p>	<p>Solution:</p> <p>Run VPL upward, remove object below platform and resume operation.</p>	<p>Comments:</p> <p>This is a normal condition and indicates the proper operation of the safety pan. A buildup of leaves or snow can cause this condition and requires removal before VPL will operate correctly.</p>
<p>Control Panel Display:</p> 	<p>Button Pressed:</p> <p>UP or DOWN</p>	<p>Symptom:</p> <p>VPL will only travel a few inches down from upper landing and Top Landing Gate indicator light illuminates when the Up or Down button is pushed.</p>	<p>Potential Cause:</p> <p>Top Landing Gate latch is not rotating to the fully closed position</p>	<p>Solution:</p> <p>Assure latch rotates freely. Check for damage which prevents latch from operating, check that catch rod on Top Landing Gate aligns properly with latch. If latch or catch rod are damaged they may need to be replaced. Consult your dealer for additional information. WARNING: Do not operate VPL while handling the latch.</p>	<p>Comments:</p> <p>The latch is spring loaded and will normally rotate into the fully closed position as the VPL travels downward and the roller loses contact with the platform side wall. If the latch is not fully closed when the VPL has traveled down approximately 2", the latch monitor switch will stop the VPL operation and the Top Landing Gate indicator light will illuminate.</p>

<p>Control Panel Display:</p> 	<p>Button Pressed:</p> <p>UP or DOWN</p>	<p>Symptom: VPL will only travel a few inches down from upper landing and Top Landing Gate indicator light illuminates when the Up or Down button is pushed.</p>	<p>Potential Cause: Top Landing Gate is not fully closed</p>	<p>Solution: Check for free swing operation of the Top Landing Gate. Also check that the spring tension on the hinges is sufficient to fully close Top Landing Gate. Adjust hinge spring tension as needed. Check that the Top Landing Gate latching mechanism is in the correct position so that the latch can fully close around the catch rod. Refer to the VPL Installation Manual Top Landing Gate Placement and Installation section for adjusting the height of the latching mechanism and Top Landing Gate.</p>	<p>Comments: The Top Landing Gate is closed by spring loaded hinges which are field adjustable to increase or decrease closing force. If the Top Landing Gate is not fully closed the Top Landing Gate monitor switch will stop the VPL operation and the Top Landing Gate indicator light will illuminate.</p>
<p>Control Panel Display:</p> 	<p>Button Pressed:</p> <p>UP</p>	<p>Symptom: VPL stops above or below the upper landing and Top Landing Gate indicator light illuminates.</p>	<p>Potential Cause: The upper limit is out of adjustment or Top Landing Gate was plugged into the VPL.</p>	<p>Solution: Unplug the Top Landing Gate from the VPL and plug the Top Landing Gate Bypass Jumper back into the plug. Adjust the upper limit trigger ramp as described in the installation manual. WARNING: This type of adjustment must be done by a qualified technician. Consult your dealer for additional information.</p>	<p>Comments: This situation indicates the upper limit is set a considerable distance above its correct position. In order to correct this adjustment the Top Landing Gate Bypass Jumper will need to be temporarily plugged into the Top Landing Gate connector so the Top Landing Gate latch will not stop the travel of VPL platform during adjustment. If the jumper is not available, the roller on the Top Landing Gate latch can be removed temporarily during adjustment so the latch is not actuated.</p>
<p>Control Panel Display:</p> 	<p>Button Pressed:</p> <p>UP or DOWN</p>	<p>Symptom: VPL will not operate and the EMERGENCY STOP indicator light is illuminated.</p>	<p>Potential Cause: EMERGENCY STOP BUTTON is activated (pushed in).</p>	<p>Solution: Pull the EMERGENCY STOP BUTTON out to deactivate. WARNING: Pressing the Emergency Stop Button/Button DOES NOT disconnect power to the battery charger. The only way to disconnect power to the battery charger is to unplug the VPL from the AC outlet.</p>	<p>Comments: The EMERGENCY STOP BUTTON disconnects power to the motor and the VPL will not operate when the button pushed in. WARNING: Pressing the Emergency Stop Button/Button DOES NOT disconnect power to the battery charger. The only way to disconnect power to the battery charger is to unplug the VPL from the AC outlet.</p>

<p>Control Panel Display:</p> 	<p>Button Pressed: UP</p>	<p>Symptom: VPL will not travel upward and service indicator light is illuminated.</p>	<p>Potential Cause: Failure of the primary hi-lead screw nut.</p>	<p>Solution: Run VPL to the bottom of its travel and exit the VPL platform. Call for service immediately! <u>DO NOT</u> attempt to operate the VPL until repairs have been completed by a qualified technician. Consult your dealer for service related information.</p>	<p>Comments: The VPL is equipped with a backup safety nut. This feature allows the unit to travel safely in the downward direction only.</p>

PROBLEM	POTENTIAL CAUSE	SOLUTION	COMMENTS
Slow, erratic operation	Batteries have discharged	See "Batteries Discharged"	
Slow, erratic operation	Very cold temperatures	Limit number of uses per day.	VPL performance falls off quickly at lower temperatures. This is inherent to lead acid batteries. Their ability to supply power and accept a recharge is diminished as temperature falls.
Slow, erratic operation	Overuse	Limit number of uses per day.	This VPL is intended for occasional use. If the unit is cycled too often the charger cannot recharge the batteries between cycles. The motor can also overheat. Several continuous cycles are acceptable as long as the unit is allowed to rest for 45 minutes to one hour before operating. One full up/down cycle requires approximately 10 to 15 minute for the charger to bring the batteries back to their charge level before cycling. Colder temperatures increase the recharge time considerably.
Slow, erratic operation	Lack of lubrication on the hi-lead® screw	Clean and lubricate the hi-lead® screw	This type of service must be done by a qualified technician. Consult your dealer for service related information.
Batteries discharged	VPL has been disconnected from power source	Plug VPL in, reset GFI (ground fault interrupter) plug, turn on or reset household circuit breaker. Verify AC connections and voltage in the junction box. WARNING: The junction box must be serviced by a qualified technician. Consult your dealer for service related information.	Under normal temperatures and loads the VPL should operate approximately 25 cycles before the batteries become discharged when disconnected from the 120VAC power source required to operate the battery charger. The indicator light in the charger will be red when the batteries are charging and green once the batteries are fully charged. NOTE: the lights on the charger can only be viewed with the power head cover removed.

PROBLEM	POTENTIAL CAUSE	SOLUTION	COMMENTS
Batteries discharged	The battery charger is not operating	Green or red indicator on charger will be illuminated if charger is receiving 120VAC power. NOTE: the lights on the charger can only be viewed with the power head cover removed.	The charger incorporates both reverse polarity and overload protection. The charger will reset once the condition is resolved. It may take a few minutes before the charger indicator light will come back on. Conditions other than overload may require diagnosis and repair by a qualified technician. Consult your dealer for service related information.
Batteries discharged	Battery charger fuse has blown	Remove power head cover and locate fuse #4 in the fuse block (FIG 19.1). If the fuse is illuminated it has blown and needs to be replaced.	The circuit between the battery charger and the batteries is fused. The fuse has an LED indicator which will light when the fuse has blown. Under normal conditions this fuse should not blow. Look for problems in the wires connected to the batteries before replacing the fuse.
Batteries discharged	Batteries are defective or near the end of their service life	Check battery age and performance level. NOTE: Performance level should only be checked by a qualified technician.	The service life of the batteries under normal conditions is approximately three years. One indication of a battery is near the end its service life is that the VPL will operate one or two times normally and then labor during additional cycles. Cold weather will make this condition worse. A newer defective battery will display much same symptoms although other potential causes described previously should be explored before considering battery replacement.

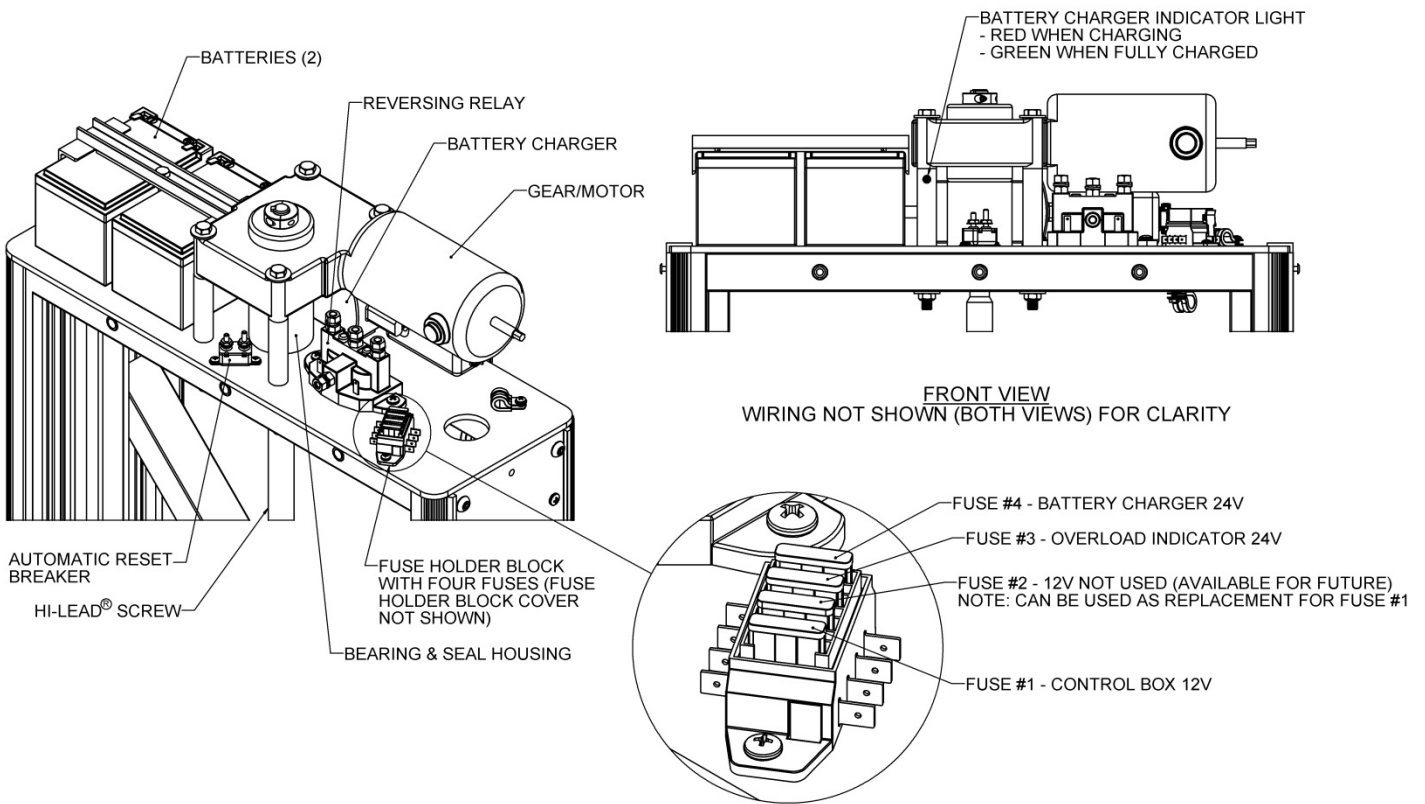


FIG. 19.1

SECTION 20 - VPL MAIN COMPONENTS DRAWING

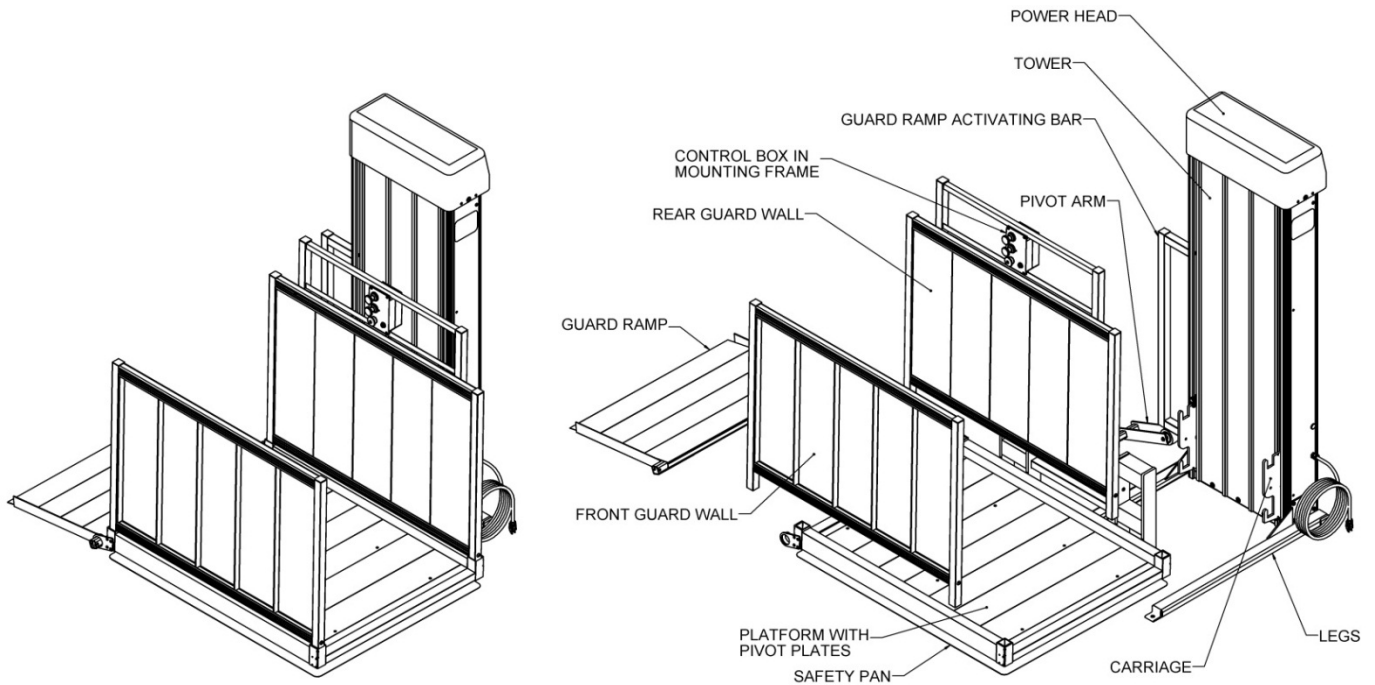


FIG. 20.1

SECTION 21 - WARRANTY

- ✎ Your VPL comes with a 2-year Limited Warranty. Contact your dealer with warranty questions, additional information requested, for replacement labels and manuals, or to schedule any needed inspections, repairs or service. Your dealer contact information can be found in Section 3 of this manual. Or you can call our Customer Service line at 1-800-451-1903 or visit us on the internet at www.ezaccess.com.