

DEALER			COLOURS INFORMATION For Office Use Only		
Dealer:			Order Date: S/N:		
Account:		P.O.#:	RTS		
Ordered By:			RTS: Phone:		
Address:			Email:		
City:		State:	Zip:		
Phone:		Fax:	SHIP TO		
Email:			Name: Ship Via:		
Customer Name:			Address:		
Customer Weight:			City: State: Zip:		
			Phone: Fax:		

CHAIR INFORMATION	PRICE
SPAZZ-G K0005	Base Wheel Chair Price K0005 \$ 1,550
Adjustable FSH-RSH	Total Section A \$
Max. Capacity 250Lbs	Total Section B \$
NOTE Spazz-G is the economical solution when you want to grow your Chair by changing the seat depth and width after ordering. Main Frame : ZK55 & ZK60 High Grade A7000 Series Aluminum Main Frame : Lifetime Warranty *See warranty policy	Total Section C \$
	Total Section D \$
	Total Section E \$
	\$
	\$
	ORDER GRAND TOTAL \$

A FRAME COLORS & PARTS COLORS

FRAME COLORS						
Powder-Co	<input type="checkbox"/> Gloss Black	<input type="checkbox"/> Twilight Flake	<input type="checkbox"/> Yellow	<input type="checkbox"/> Magenta	<input type="checkbox"/> Fire Engine Red	<input type="checkbox"/> White
	<input type="checkbox"/> Candy Blue	<input type="checkbox"/> Candy Purple	<input type="checkbox"/> Candy Green	<input type="checkbox"/> Candy Red	<input type="checkbox"/> Candy Raspberry	<input type="checkbox"/> Cobalt Blue
	<input type="checkbox"/> Matte Gray	<input type="checkbox"/> Matte Purple	<input type="checkbox"/> Matte Blue	<input type="checkbox"/> Matte Green	<input type="checkbox"/> Matte Black	<input type="checkbox"/> Matte Red
	<input type="checkbox"/> Neon Red	<input type="checkbox"/> Neon Green	<input type="checkbox"/> Orange Sparkle	<input type="checkbox"/> Mellon Yellow	<input type="checkbox"/> Gun Smoke Silver	<input type="checkbox"/> Pigeon Blue
	<input type="checkbox"/> Copper	<input type="checkbox"/> Granny Sparkle Green	<input type="checkbox"/> Sparkle Sky Blue	<input type="checkbox"/> Vermilion	<input type="checkbox"/> Reed Green	<input type="checkbox"/> Blue Lilac
						\$ STD
Special	<input type="checkbox"/> Polished					\$ 800
	<input type="checkbox"/> 24 karat Gold Plated					\$ CFP

PARTS COLORS	
STD Color Black Color (*Suspension Springs-Silver Color)	\$ STD
Custom Color Main Bolt on Parts One Color Package	<input type="checkbox"/> Powder-Coated () .. \$ 500
Including: Backrest, Foot Plate, Footrest Rings, Backrest Brackets , Saddle Stops,	<input type="checkbox"/> Polished \$ 750
Forks & Knurl Nuts, Caps, Front Suspension Springs, Axle Tube, Axle Clamps, Axle Plates,	<input type="checkbox"/> 24 karat Gold Plated \$ CFP
Axle Bases, Camber Discs, Caster Housings ☆marked parts	

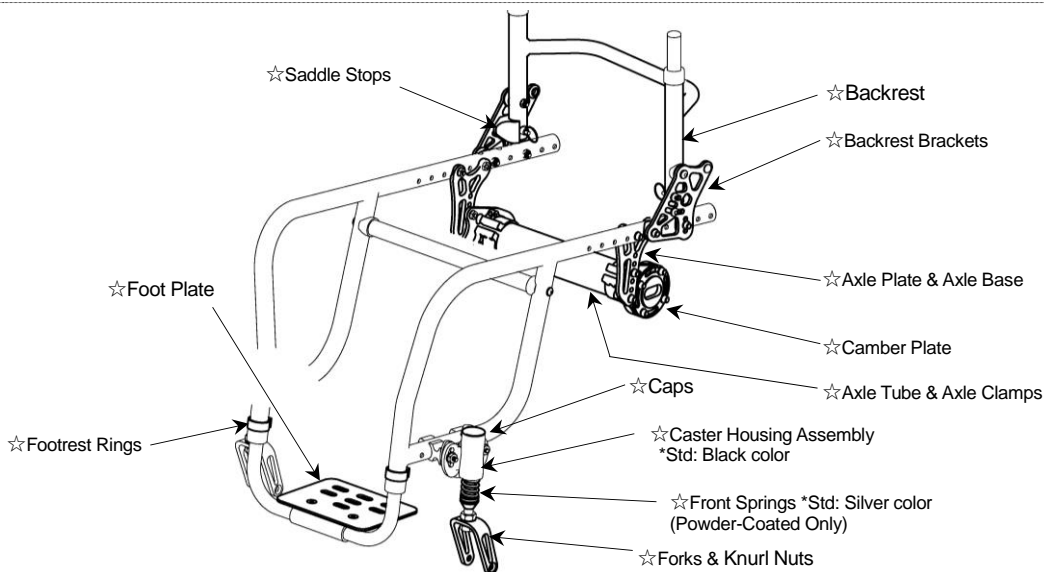

Total Section A \$

B FRAME MEASUREMENTS 1/2

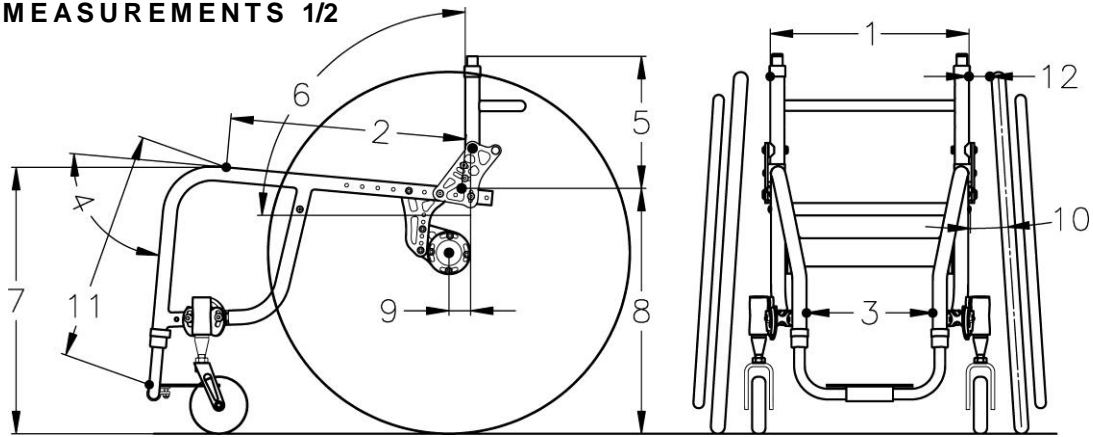

1. SEAT WIDTH	<input type="checkbox"/> 14" <input type="checkbox"/> 15" <input type="checkbox"/> 16" <input type="checkbox"/> 17" <input type="checkbox"/> 18" 	\$ STD
	<input type="checkbox"/> 19" <input type="checkbox"/> 20" 	\$ 284

2. SEAT DEPTH	Depth Adj. Frame <input type="checkbox"/> Short Frame (16" Depth) Set at <input type="checkbox"/> 13" <input type="checkbox"/> 14" <input type="checkbox"/> 15" <input type="checkbox"/> 16" 	\$ STD
	<input type="checkbox"/> Long Frame (19" Depth) Set at <input type="checkbox"/> 15" <input type="checkbox"/> 16" <input type="checkbox"/> 17" <input type="checkbox"/> 18" <input type="checkbox"/> 19"	\$ STD

3. FOOTREST WIDTH	<input type="checkbox"/> STD (Seat Width Minus 5", Taper on Bottom Frame) 	\$ STD
--------------------------	---	--------

*No Custom Modifications

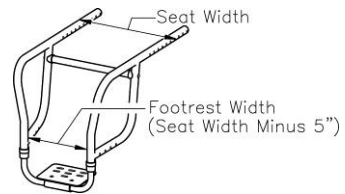

FOOT PLATE STYLE	<input type="checkbox"/> Standard single loop with adjust. height & angle. STD Foot Plate 	K0040 \$ STD
	<input type="checkbox"/> Single Flip-Back-single loop (no riser avail) with adjust. height & angle. STD Foot Plate 	K0040 \$ 150

STD Foot Plate Size Chart

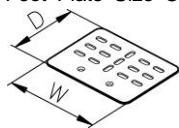

Your Seat Width	Foot Plate Size
14"-15"	W6.5"xD5"
16"-18"	W8.5"xD6.5"
19"-20"	W11"xD6.5"

*No Custom Modifications

4. FRAME BEND ANGLE	<input type="checkbox"/> 90° only 	\$ STD
----------------------------	--	--------

*No Custom Modifications

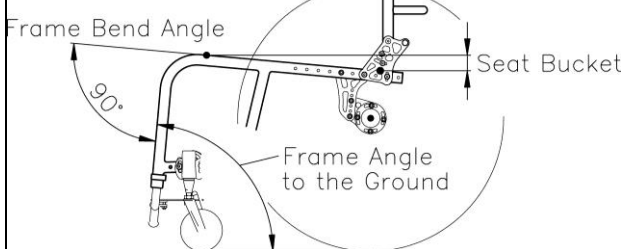

FRAME ANGLE to the Ground

		Your Seat Depth							
		13"	14"	15"	16"	17"	18"	19"	20"
Seat Bucket	0"	90°	90°	90°	90°	90°	90°	90°	90°
	1"	86°	86°	86°	86°	87°	87°	87°	87°
	2"	81°	82°	82°	83°	83°	84°	84°	84°
	3"	77°	78°	78°	79°	80°	80°	81°	81°
	4"	72°	73°	75°	76°	76°	77°	78°	78°
	5"	67°	69°	71°	72°	73°	74°	75°	76°

B FRAME MEASUREMENTS 2/2

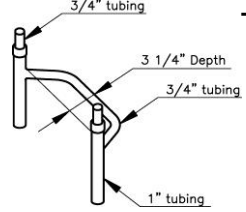
5. BACKREST HEIGHT * Rigidizer bar 3.25" deep std.	<input type="checkbox"/> 8" <input type="checkbox"/> 9" <input type="checkbox"/> 10" <input type="checkbox"/> 11" <input type="checkbox"/> 12" <input type="checkbox"/> 13" <input type="checkbox"/> 14" <input type="checkbox"/> 15" <input type="checkbox"/> 16" <input type="checkbox"/> 17" <input type="checkbox"/> 18"	Adj. Range	Adj. Range	Adj. Range	Adj. Range	Adj. Range	Adj. Range	Adj. Range	Adj. Range	\$ STD																																																																																																																	
	Type									\$ STD																																																																																																																	
	<input type="checkbox"/> Locking mechan. with adjust. height & angle									\$ STD																																																																																																																	
	<input type="checkbox"/> Double Locking mechan. with adjust. height & angle									\$ 25																																																																																																																	
	<input type="checkbox"/> Folding with adjust. height & angle									\$ NCO																																																																																																																	
*No Custom Modifications																																																																																																																											
6. BACKREST ANGLE	Set at (°) to the ground *STD 90°									\$ STD																																																																																																																	
7. FRONT SEAT HEIGHT	<input type="checkbox"/> 17.5" <input type="checkbox"/> 18.0" <input type="checkbox"/> 18.5" <input type="checkbox"/> 19.0" <input type="checkbox"/> 19.5" <input type="checkbox"/> 20.0" <input type="checkbox"/> 20.5"									\$ STD																																																																																																																	
The front seat heights are impacted by the size of your front caster.																																																																																																																											
STD Front Seat Height Ranges *No Custom Modifications																																																																																																																											
<table border="1" style="width:100%; border-collapse: collapse;"> <thead> <tr> <th colspan="2" rowspan="2"></th> <th colspan="7">Front Seat Height</th> </tr> <tr> <th>17.5"</th> <th>18.0"</th> <th>18.5"</th> <th>19.0"</th> <th>19.5"</th> <th>20.0"</th> <th>20.5"</th> </tr> </thead> <tbody> <tr> <td rowspan="10" style="writing-mode: vertical-rl; transform: rotate(180deg);">Your Casters & Forks</td> <td>3" Caster & STD Forks</td> <td><input type="checkbox"/></td><td><input type="checkbox"/></td><td><input type="checkbox"/></td><td><input type="checkbox"/></td><td><input type="checkbox"/></td><td><input type="checkbox"/></td><td><input type="checkbox"/></td> </tr> <tr> <td>3" Caster & Springs</td> <td><input type="checkbox"/></td><td><input type="checkbox"/></td><td><input type="checkbox"/></td><td><input type="checkbox"/></td><td><input type="checkbox"/></td><td><input type="checkbox"/></td><td><input type="checkbox"/></td> </tr> <tr> <td>3" Caster & Frog Legs</td> <td><input type="checkbox"/></td><td><input type="checkbox"/></td><td><input checked="" type="checkbox"/>*</td><td><input checked="" type="checkbox"/>*</td><td><input checked="" type="checkbox"/>*</td><td><input checked="" type="checkbox"/>*</td><td><input checked="" type="checkbox"/>*</td> </tr> <tr> <td>4" Caster & STD Forks</td> <td><input type="checkbox"/></td><td><input type="checkbox"/></td><td><input type="checkbox"/></td><td><input type="checkbox"/></td><td><input type="checkbox"/></td><td><input type="checkbox"/></td><td><input type="checkbox"/></td> </tr> <tr> <td>4" Caster & Springs</td> <td><input type="checkbox"/></td><td><input type="checkbox"/></td><td><input type="checkbox"/></td><td><input type="checkbox"/></td><td><input type="checkbox"/></td><td><input type="checkbox"/></td><td><input type="checkbox"/></td> </tr> <tr> <td>4" Caster & Frog Legs</td> <td><input type="checkbox"/></td><td><input type="checkbox"/></td><td><input checked="" type="checkbox"/>*</td><td><input checked="" type="checkbox"/>*</td><td><input checked="" type="checkbox"/>*</td><td><input checked="" type="checkbox"/>*</td><td><input checked="" type="checkbox"/>*</td> </tr> <tr> <td>5" Caster & STD Forks</td> <td><input type="checkbox"/></td><td><input type="checkbox"/></td><td><input checked="" type="checkbox"/>*</td><td><input checked="" type="checkbox"/>*</td><td><input checked="" type="checkbox"/>*</td><td><input checked="" type="checkbox"/>*</td><td><input checked="" type="checkbox"/>*</td> </tr> <tr> <td>5" Caster & Springs</td> <td><input type="checkbox"/></td><td><input type="checkbox"/></td><td><input checked="" type="checkbox"/>*</td><td><input checked="" type="checkbox"/>*</td><td><input checked="" type="checkbox"/>*</td><td><input checked="" type="checkbox"/>*</td><td><input checked="" type="checkbox"/>*</td> </tr> <tr> <td>5" Caster & Frog Legs</td> <td><input type="checkbox"/></td><td><input type="checkbox"/></td><td><input checked="" type="checkbox"/>*</td><td><input checked="" type="checkbox"/>*</td><td><input checked="" type="checkbox"/>*</td><td><input checked="" type="checkbox"/>*</td><td><input checked="" type="checkbox"/>*</td> </tr> </tbody> </table>												Front Seat Height							17.5"	18.0"	18.5"	19.0"	19.5"	20.0"	20.5"	Your Casters & Forks	3" Caster & STD Forks	<input type="checkbox"/>	<input type="checkbox"/>	<input type="checkbox"/>	<input type="checkbox"/>	<input type="checkbox"/>	<input type="checkbox"/>	<input type="checkbox"/>	3" Caster & Springs	<input type="checkbox"/>	<input type="checkbox"/>	<input type="checkbox"/>	<input type="checkbox"/>	<input type="checkbox"/>	<input type="checkbox"/>	<input type="checkbox"/>	3" Caster & Frog Legs	<input type="checkbox"/>	<input type="checkbox"/>	<input checked="" type="checkbox"/> *	<input checked="" type="checkbox"/> *	<input checked="" type="checkbox"/> *	<input checked="" type="checkbox"/> *	<input checked="" type="checkbox"/> *	4" Caster & STD Forks	<input type="checkbox"/>	<input type="checkbox"/>	<input type="checkbox"/>	<input type="checkbox"/>	<input type="checkbox"/>	<input type="checkbox"/>	<input type="checkbox"/>	4" Caster & Springs	<input type="checkbox"/>	<input type="checkbox"/>	<input type="checkbox"/>	<input type="checkbox"/>	<input type="checkbox"/>	<input type="checkbox"/>	<input type="checkbox"/>	4" Caster & Frog Legs	<input type="checkbox"/>	<input type="checkbox"/>	<input checked="" type="checkbox"/> *	<input checked="" type="checkbox"/> *	<input checked="" type="checkbox"/> *	<input checked="" type="checkbox"/> *	<input checked="" type="checkbox"/> *	5" Caster & STD Forks	<input type="checkbox"/>	<input type="checkbox"/>	<input checked="" type="checkbox"/> *	<input checked="" type="checkbox"/> *	<input checked="" type="checkbox"/> *	<input checked="" type="checkbox"/> *	<input checked="" type="checkbox"/> *	5" Caster & Springs	<input type="checkbox"/>	<input type="checkbox"/>	<input checked="" type="checkbox"/> *	<input checked="" type="checkbox"/> *	<input checked="" type="checkbox"/> *	<input checked="" type="checkbox"/> *	<input checked="" type="checkbox"/> *	5" Caster & Frog Legs	<input type="checkbox"/>	<input type="checkbox"/>	<input checked="" type="checkbox"/> *	<input checked="" type="checkbox"/> *	<input checked="" type="checkbox"/> *	<input checked="" type="checkbox"/> *	<input checked="" type="checkbox"/> *																									
		Front Seat Height																																																																																																																									
		17.5"	18.0"	18.5"	19.0"	19.5"	20.0"	20.5"																																																																																																																			
Your Casters & Forks	3" Caster & STD Forks	<input type="checkbox"/>	<input type="checkbox"/>	<input type="checkbox"/>	<input type="checkbox"/>	<input type="checkbox"/>	<input type="checkbox"/>	<input type="checkbox"/>																																																																																																																			
	3" Caster & Springs	<input type="checkbox"/>	<input type="checkbox"/>	<input type="checkbox"/>	<input type="checkbox"/>	<input type="checkbox"/>	<input type="checkbox"/>	<input type="checkbox"/>																																																																																																																			
	3" Caster & Frog Legs	<input type="checkbox"/>	<input type="checkbox"/>	<input checked="" type="checkbox"/> *	<input checked="" type="checkbox"/> *	<input checked="" type="checkbox"/> *	<input checked="" type="checkbox"/> *	<input checked="" type="checkbox"/> *																																																																																																																			
	4" Caster & STD Forks	<input type="checkbox"/>	<input type="checkbox"/>	<input type="checkbox"/>	<input type="checkbox"/>	<input type="checkbox"/>	<input type="checkbox"/>	<input type="checkbox"/>																																																																																																																			
	4" Caster & Springs	<input type="checkbox"/>	<input type="checkbox"/>	<input type="checkbox"/>	<input type="checkbox"/>	<input type="checkbox"/>	<input type="checkbox"/>	<input type="checkbox"/>																																																																																																																			
	4" Caster & Frog Legs	<input type="checkbox"/>	<input type="checkbox"/>	<input checked="" type="checkbox"/> *	<input checked="" type="checkbox"/> *	<input checked="" type="checkbox"/> *	<input checked="" type="checkbox"/> *	<input checked="" type="checkbox"/> *																																																																																																																			
	5" Caster & STD Forks	<input type="checkbox"/>	<input type="checkbox"/>	<input checked="" type="checkbox"/> *	<input checked="" type="checkbox"/> *	<input checked="" type="checkbox"/> *	<input checked="" type="checkbox"/> *	<input checked="" type="checkbox"/> *																																																																																																																			
	5" Caster & Springs	<input type="checkbox"/>	<input type="checkbox"/>	<input checked="" type="checkbox"/> *	<input checked="" type="checkbox"/> *	<input checked="" type="checkbox"/> *	<input checked="" type="checkbox"/> *	<input checked="" type="checkbox"/> *																																																																																																																			
	5" Caster & Frog Legs	<input type="checkbox"/>	<input type="checkbox"/>	<input checked="" type="checkbox"/> *	<input checked="" type="checkbox"/> *	<input checked="" type="checkbox"/> *	<input checked="" type="checkbox"/> *	<input checked="" type="checkbox"/> *																																																																																																																			
	*Not Available with Quick Release Caster Axle.																																																																																																																										
8. REAR SEAT HEIGHT	<input type="checkbox"/> 14.5" <input type="checkbox"/> 15.0" <input type="checkbox"/> 15.5" <input type="checkbox"/> 16.0" <input type="checkbox"/> 16.5" <input type="checkbox"/> 17.0" <input type="checkbox"/> 17.5" <input type="checkbox"/> 18.0" <input type="checkbox"/> 18.5" <input type="checkbox"/> 19.0"								\$ STD																																																																																																																		
STD Rear Seat Height Ranges *No Custom Modifications																																																																																																																											
<table border="1" style="width:100%; border-collapse: collapse;"> <thead> <tr> <th>Rear Tire Size</th> <th>Rear Seat Height</th> </tr> </thead> <tbody> <tr> <td>24"x1"(540)</td> <td>14.5" - 18.0"</td> </tr> <tr> <td>24"x1 3/8"(540)</td> <td>15.0" - 18.0"</td> </tr> <tr> <td>25"x1"(559)</td> <td>15.5" - 18.0"</td> </tr> <tr> <td>24"x2"(540)</td> <td>15.5" - 18.5"</td> </tr> <tr> <td>26"x1"(590)</td> <td>15.5" - 19.0"</td> </tr> <tr> <td>25"x1.95"(559)</td> <td>16.0" - 19.0"</td> </tr> </tbody> </table>										Rear Tire Size	Rear Seat Height	24"x1"(540)	14.5" - 18.0"	24"x1 3/8"(540)	15.0" - 18.0"	25"x1"(559)	15.5" - 18.0"	24"x2"(540)	15.5" - 18.5"	26"x1"(590)	15.5" - 19.0"	25"x1.95"(559)	16.0" - 19.0"																																																																																																				
Rear Tire Size	Rear Seat Height																																																																																																																										
24"x1"(540)	14.5" - 18.0"																																																																																																																										
24"x1 3/8"(540)	15.0" - 18.0"																																																																																																																										
25"x1"(559)	15.5" - 18.0"																																																																																																																										
24"x2"(540)	15.5" - 18.5"																																																																																																																										
26"x1"(590)	15.5" - 19.0"																																																																																																																										
25"x1.95"(559)	16.0" - 19.0"																																																																																																																										
9. CENTER OF GRAVITY	<input type="checkbox"/> 1.0" <input type="checkbox"/> 1.5" <input type="checkbox"/> 2.0" <input type="checkbox"/> 2.5" <input type="checkbox"/> 3.0" <input type="checkbox"/> 3.5" <input type="checkbox"/> 4.0" <input type="checkbox"/> 4.5" <input type="checkbox"/> 5.0" <input type="checkbox"/> 5.5"								\$ STD																																																																																																																		
Center of Gravity Ranges																																																																																																																											
<table border="1" style="width:100%; border-collapse: collapse;"> <thead> <tr> <th colspan="2" rowspan="2"></th> <th colspan="10">Your Center of Gravity</th> </tr> <tr> <th>1.0"</th> <th>1.5"</th> <th>2.0"</th> <th>2.5"</th> <th>3.0"</th> <th>3.5"</th> <th>4.0"</th> <th>4.5"</th> <th>5.0"</th> <th>5.5"</th> </tr> </thead> <tbody> <tr> <td rowspan="8" style="writing-mode: vertical-rl; transform: rotate(180deg);">Your Seat Depth</td> <td>13"</td> <td><input type="checkbox"/></td><td><input checked="" type="checkbox"/>*</td><td><input checked="" type="checkbox"/>*</td><td></td><td></td><td></td><td></td><td></td><td></td><td></td><td></td><td></td> </tr> <tr> <td>14"</td> <td><input type="checkbox"/></td><td><input type="checkbox"/></td><td><input checked="" type="checkbox"/>*</td><td><input checked="" type="checkbox"/>*</td><td></td><td></td><td></td><td></td><td></td><td></td><td></td><td></td> </tr> <tr> <td>15"</td> <td><input type="checkbox"/></td><td><input type="checkbox"/></td><td><input type="checkbox"/></td><td><input type="checkbox"/></td><td><input checked="" type="checkbox"/>*</td><td><input checked="" type="checkbox"/>*</td><td></td><td></td><td></td><td></td><td></td><td></td> </tr> <tr> <td>16"</td> <td><input type="checkbox"/></td><td><input type="checkbox"/></td><td><input type="checkbox"/></td><td><input type="checkbox"/></td><td><input type="checkbox"/></td><td><input checked="" type="checkbox"/>*</td><td><input checked="" type="checkbox"/>*</td><td></td><td></td><td></td><td></td><td></td> </tr> <tr> <td>17"</td> <td><input checked="" type="checkbox"/>*</td><td><input type="checkbox"/></td><td><input type="checkbox"/></td><td><input type="checkbox"/></td><td><input type="checkbox"/></td><td><input type="checkbox"/></td><td><input type="checkbox"/></td><td><input checked="" type="checkbox"/>*</td><td><input checked="" type="checkbox"/>*</td><td></td><td></td><td></td> </tr> <tr> <td>18"</td> <td><input checked="" type="checkbox"/>*</td><td><input type="checkbox"/></td><td><input type="checkbox"/></td><td><input type="checkbox"/></td><td><input type="checkbox"/></td><td><input type="checkbox"/></td><td><input type="checkbox"/></td><td><input type="checkbox"/></td><td><input type="checkbox"/></td><td><input type="checkbox"/></td><td><input checked="" type="checkbox"/>*</td><td></td> </tr> <tr> <td>19"</td> <td><input checked="" type="checkbox"/>*</td><td><input checked="" type="checkbox"/>*</td><td><input type="checkbox"/></td><td><input type="checkbox"/></td><td><input type="checkbox"/></td><td><input type="checkbox"/></td><td><input type="checkbox"/></td><td><input type="checkbox"/></td><td><input type="checkbox"/></td><td><input type="checkbox"/></td><td><input type="checkbox"/></td><td><input type="checkbox"/></td> </tr> </tbody> </table>												Your Center of Gravity										1.0"	1.5"	2.0"	2.5"	3.0"	3.5"	4.0"	4.5"	5.0"	5.5"	Your Seat Depth	13"	<input type="checkbox"/>	<input checked="" type="checkbox"/> *	<input checked="" type="checkbox"/> *										14"	<input type="checkbox"/>	<input type="checkbox"/>	<input checked="" type="checkbox"/> *	<input checked="" type="checkbox"/> *									15"	<input type="checkbox"/>	<input type="checkbox"/>	<input type="checkbox"/>	<input type="checkbox"/>	<input checked="" type="checkbox"/> *	<input checked="" type="checkbox"/> *							16"	<input type="checkbox"/>	<input type="checkbox"/>	<input type="checkbox"/>	<input type="checkbox"/>	<input type="checkbox"/>	<input checked="" type="checkbox"/> *	<input checked="" type="checkbox"/> *						17"	<input checked="" type="checkbox"/> *	<input type="checkbox"/>	<input type="checkbox"/>	<input type="checkbox"/>	<input type="checkbox"/>	<input type="checkbox"/>	<input type="checkbox"/>	<input checked="" type="checkbox"/> *	<input checked="" type="checkbox"/> *				18"	<input checked="" type="checkbox"/> *	<input type="checkbox"/>	<input type="checkbox"/>	<input type="checkbox"/>	<input type="checkbox"/>	<input type="checkbox"/>	<input type="checkbox"/>	<input type="checkbox"/>	<input type="checkbox"/>	<input type="checkbox"/>	<input checked="" type="checkbox"/> *		19"	<input checked="" type="checkbox"/> *	<input checked="" type="checkbox"/> *	<input type="checkbox"/>	<input type="checkbox"/>	<input type="checkbox"/>	<input type="checkbox"/>	<input type="checkbox"/>	<input type="checkbox"/>	<input type="checkbox"/>	<input type="checkbox"/>	<input type="checkbox"/>	<input type="checkbox"/>
		Your Center of Gravity																																																																																																																									
		1.0"	1.5"	2.0"	2.5"	3.0"	3.5"	4.0"	4.5"	5.0"	5.5"																																																																																																																
Your Seat Depth	13"	<input type="checkbox"/>	<input checked="" type="checkbox"/> *	<input checked="" type="checkbox"/> *																																																																																																																							
	14"	<input type="checkbox"/>	<input type="checkbox"/>	<input checked="" type="checkbox"/> *	<input checked="" type="checkbox"/> *																																																																																																																						
	15"	<input type="checkbox"/>	<input type="checkbox"/>	<input type="checkbox"/>	<input type="checkbox"/>	<input checked="" type="checkbox"/> *	<input checked="" type="checkbox"/> *																																																																																																																				
	16"	<input type="checkbox"/>	<input type="checkbox"/>	<input type="checkbox"/>	<input type="checkbox"/>	<input type="checkbox"/>	<input checked="" type="checkbox"/> *	<input checked="" type="checkbox"/> *																																																																																																																			
	17"	<input checked="" type="checkbox"/> *	<input type="checkbox"/>	<input type="checkbox"/>	<input type="checkbox"/>	<input type="checkbox"/>	<input type="checkbox"/>	<input type="checkbox"/>	<input checked="" type="checkbox"/> *	<input checked="" type="checkbox"/> *																																																																																																																	
	18"	<input checked="" type="checkbox"/> *	<input type="checkbox"/>	<input type="checkbox"/>	<input type="checkbox"/>	<input type="checkbox"/>	<input type="checkbox"/>	<input type="checkbox"/>	<input type="checkbox"/>	<input type="checkbox"/>	<input type="checkbox"/>	<input checked="" type="checkbox"/> *																																																																																																															
	19"	<input checked="" type="checkbox"/> *	<input checked="" type="checkbox"/> *	<input type="checkbox"/>	<input type="checkbox"/>	<input type="checkbox"/>	<input type="checkbox"/>	<input type="checkbox"/>	<input type="checkbox"/>	<input type="checkbox"/>	<input type="checkbox"/>	<input type="checkbox"/>	<input type="checkbox"/>																																																																																																														
	☆=Not Available Scissor Wheel Lock ★=Excludes 24" x 2", 26" x 1", 25" x 1.95" tires are selected.																																																																																																																										
10. CAMBER ANGLE	<input type="checkbox"/> 2° <input type="checkbox"/> 4° <input type="checkbox"/> 6°								\$ STD																																																																																																																		
11. FRONT OF SEAT SLING TO FRONT OF FOOTREST	<input type="checkbox"/> 15.0" <input type="checkbox"/> 15.5" <input type="checkbox"/> 16.0" <input type="checkbox"/> 16.5" <input type="checkbox"/> 17.0" <input type="checkbox"/> 17.5" <input type="checkbox"/> 18.0" <input type="checkbox"/> 18.5" <input type="checkbox"/> 19.0" <input type="checkbox"/> 19.5"								\$ STD																																																																																																																		
*Measurement must be 1.5" shorter than your Front Seat Height																																																																																																																											
HIGH MOUNT With Risers or Clamps	<input type="checkbox"/> 9.5" <input type="checkbox"/> 10.0" <input type="checkbox"/> 10.5" <input type="checkbox"/> 11.0" <input type="checkbox"/> 11.5" <input type="checkbox"/> 12.0" <input type="checkbox"/> 12.5" <input type="checkbox"/> 13.0" <input type="checkbox"/> 13.5" <input type="checkbox"/> 14.0" <input type="checkbox"/> 14.5"								\$ 65																																																																																																																		
12. INSIDE WHEEL CLEARANCE	<input type="checkbox"/> 3/4" * <input type="checkbox"/> 1" <input type="checkbox"/> 1 1/4" <input type="checkbox"/> 1 1/2" <input type="checkbox"/> 1 3/4" <input type="checkbox"/> 2"								\$ STD																																																																																																																		
*3/4" Inside wheel clearance not available with 2 degree camber. (with the exception of Y-360 wheels) *3/4" Inside wheel clearance not available with Armrest *3/4" Inside wheel clearance not available with D's Locks																																																																																																																											
NOTE																																																																																																																											
Sub Total Section B 1/2									\$																																																																																																																		
Sub Total Section B 2/2									\$																																																																																																																		
Total Section B									\$																																																																																																																		

C WHEELS, TIRES & CASTERS, FORKS 1/2

WHEELS			
Standard Radial Spoke Wheel	<input type="checkbox"/> 24" (540) Only		\$ STD
Heat-Treated Wheel	<input type="checkbox"/> 24" (540) <input type="checkbox"/> 25" (559) <input type="checkbox"/> 26" (590)		\$ 250
Cross Knot Laced Spokes	<input type="checkbox"/> 24" (540) <input type="checkbox"/> 25" (559) <input type="checkbox"/> 26" (590)		\$ 250
Twister Super Strength Wheel	<input type="checkbox"/> 24" (540) <input type="checkbox"/> 25" (559) <input type="checkbox"/> 26" (590)		\$ 300
SUN Fusion 16 Wheel	<input type="checkbox"/> 24" (540) <input type="checkbox"/> 25" (559)		\$ 410
16 Black Spokes	Hub Color <input type="checkbox"/> Black <input type="checkbox"/> Silver		
Y-360 Billet Wheels	<input type="checkbox"/> 24" (540) <input type="checkbox"/> 25" (559)	Style <input type="checkbox"/> Saw Blade <input type="checkbox"/> Hearts(25"only) <input type="checkbox"/> T-Style(25"only)	\$ 999
*Max. Capacity 220Lbs *Camber 0- 2° max *Not for Sports or Rugged use			
Y-360 Billet Wheels MOD Style	<input type="checkbox"/> 25" (559) Only	Style <input type="checkbox"/> Tribal Sun <input type="checkbox"/> Girls <input type="checkbox"/> Eagle <input type="checkbox"/> Holy Cross <input type="checkbox"/> Hono	\$ 1,499
*Max. Capacity 220Lbs *Camber 0- 2° max *Not for Sports or Rugged use			
Specify Powder Coat Color for Insert Only () *Choose from Frame Colors			
Extra Options for Y-360	<input type="checkbox"/> Spinners Clover (\$650 up charge) <input type="checkbox"/> Powder-Coated Spokes Only () *Choose from Frame Colors (\$150 up charge)		
X-Core (3 Spokes comp)	<input type="checkbox"/> 25" (559) Only	Wheel Color <input type="checkbox"/> Black <input type="checkbox"/> Yellow <input type="checkbox"/> Blue <input type="checkbox"/> Red <input type="checkbox"/> White	\$ 743 \$ 943
*Camber 0- 2° max *Not available with D's Lock *Not available with long tabs			
Spinergy Spox	<input type="checkbox"/> 24" (540) <input type="checkbox"/> 25" (559) <input type="checkbox"/> 26" (590)	Spoke Color <input type="checkbox"/> Black <input type="checkbox"/> Red <input type="checkbox"/> Yellow <input type="checkbox"/> Blue <input type="checkbox"/> White	\$ 695
18 Spokes	With Silver Hub With Black Hub With Black Hub With Black Hub With Black Hub	<input type="checkbox"/> Custom Color Spoke Pattern	
		Left Wheel Right Wheel	\$ 795
	Spokes Color Hub Color	Inside Outside	
		<input type="checkbox"/> Black/ <input type="checkbox"/> Silver <input type="checkbox"/> Black/ <input type="checkbox"/> Silver	
Spinergy LX	<input type="checkbox"/> 24" (540) <input type="checkbox"/> 25" (559) <input type="checkbox"/> 26" (590)	Spoke Color <input type="checkbox"/> Black <input type="checkbox"/> Red <input type="checkbox"/> Yellow <input type="checkbox"/> Blue <input type="checkbox"/> White <input type="checkbox"/> Neon Green <input type="checkbox"/> Pink <input type="checkbox"/> Orange	\$ 895
12 Spokes	With Silver Hub With Black Hub With Black Hub With Black Hub With Black Hub	<input type="checkbox"/> Custom Color Spoke Pattern	
		Left Wheel Right Wheel	\$ 995
	Spokes Color Hub Color	Inside Outside	
		<input type="checkbox"/> Black/ <input type="checkbox"/> Silver <input type="checkbox"/> Black/ <input type="checkbox"/> Silver	
Topolino Cabon Core WX2.5 Wheels	Black Spokes Only <input type="checkbox"/> 24" (540) <input type="checkbox"/> 25" (559)	*Max. Capacity 220Lbs	\$ 1,095
*Not available with D's Lock Nipples Color <input type="checkbox"/> Red <input type="checkbox"/> Yellow			
Pro Wheels	<input type="checkbox"/> 24" (540) <input type="checkbox"/> 25" (559)	Spoke & Handrim Color <input type="checkbox"/> Anodized Black <input type="checkbox"/> Anodized Red <input type="checkbox"/> Anodized Blue	\$ 825
w/ Aluminum Color Anodized Handrim *Not available with D's Lock			
HANDRIMS			
Type	<input type="checkbox"/> Standard For 24", 25" or 26" Wheel Anodized Black (*Not available with Pro Wheels)		\$ STD
	<input type="checkbox"/> Vinyl Coated For 24", 25", 26" Wheel (*Not available with Pro Wheels)		\$ 142
	<input type="checkbox"/> Natural Fit For 24", 25" Wheel		
	<input type="checkbox"/> Standard Grip (Not available with short tabs. Not available with Y-360 Billet Wheels, X-Core, Topolino Wheels, Pro Wheels, Mag Wheels)		\$ 295
	<input type="checkbox"/> Super Grip (Not available with short tabs. Not available with Y-360 Billet Wheels, X-Core, Topolino Wheels, Pro Wheels, Mag Wheels)		\$ 340
	<input type="checkbox"/> Without Thumb Grip (Not available with Y-360 Billet Wheels, Not available with Pro Wheels, Mag Wheels)		\$ 270
	<input type="checkbox"/> Natural Fit (LT) For 24", 25" Wheel		
	<input type="checkbox"/> Standard Grip (Not available with short tabs. Not available with Y-360 Billet Wheels, X-Core, Topolino Wheels, Pro Wheels, Mag Wheels)		\$ 325
	<input type="checkbox"/> Super Grip (Not available with short tabs. Not available with Y-360 Billet Wheels, X-Core, Topolino Wheels, Pro Wheels, Mag Wheels)		\$ 370
	<input type="checkbox"/> Without Thumb Grip (Not available with Y-360 Billet Wheels, Not available with Pro Wheels, Mag Wheels)		\$ 300
	<input type="checkbox"/> The Surge Handrims * Not available with Y-360 Billet Wheels * w / X-Core Wheels required Installation fee (\$30) flat fee		\$ 315
	<input type="checkbox"/> The Surge Handrims (LT) * Not available with Y-360 Billet Wheels * w / X-Core Wheels required Installation fee (\$30) flat fee		\$ 340
	<input type="checkbox"/> Spinergy Flex Rim Available only on 24" and 25" Spinergy LX.		\$ 495
	<input type="checkbox"/> Projections Handrims *Not available with Y-360 Billet Wheels, X-Core, Topolino Wheels, Pro Wheels, Mag Wheels)	E0967	\$ CFP
*Call For Availability			
TAB LENGTH	<input type="checkbox"/> Long Tab (STD inside clearance 3/4") * Not available with X-Core Wheels		\$ STD
	<input type="checkbox"/> Short Tab (Inside clearance 1/2") *Not available with Ultra Grip and Natural Fit Handrim with thumb grip		\$ STD
	<input type="checkbox"/> Short Tab (Set closest to wheel cut off excess) * Not available with Y-360 wheel, Pro Wheels, X-Core, Pro Wheels		\$ 15

C WHEELS, TIRES & CASTERS, FORKS 2/2

TIRES			
<input type="checkbox"/>	High Pressure Tire	<input type="checkbox"/> 24"x1", <input type="checkbox"/> 25"x1" or <input type="checkbox"/> 26"x1"	Gray Tire with black wall Only E2211/E2212 \$ STD
<input type="checkbox"/>	High Pressure Tire	<input type="checkbox"/> 24"x1", <input type="checkbox"/> 25"x1" or <input type="checkbox"/> 26"x1"	<input type="checkbox"/> Blue <input type="checkbox"/> Red E2211/E2212 \$ 65
<input type="checkbox"/>	Low Pressure Tire	<input type="checkbox"/> 24"x1-3/8" or <input type="checkbox"/> 26"x1-3/8"	Gray Only E2211/E2212 \$ STD
<input type="checkbox"/>	E2211Schwalbe Marathon Plus High Pressure Tire	<input type="checkbox"/> 24"x1", <input type="checkbox"/> 25"x1" or <input type="checkbox"/> 26"x1"	Black Only E2211/E2212 \$ 99
<input type="checkbox"/>	Solid Tire	<input type="checkbox"/> 24"x1", <input type="checkbox"/> 25"x1" or <input type="checkbox"/> 26"x1"	<input type="checkbox"/> Dark Gray <input type="checkbox"/> Black(\$30up charge) E2218 \$ 135
<input type="checkbox"/>	E2211 Moderate V-Track Knobby Tire	24"x1-3/8" (37-540)	Gray Only E2211/E2212 \$ 117
<input type="checkbox"/>	E2211 Aggressive Knobby Tire	24"x 2" (50-540)	Gray Only E2211/E2212 \$ 117
<input type="checkbox"/>	E2211 Aggressive Knobby Tire	26"x 1.95" (50-559)	Black Only E2211/E2212 \$ 117
<input type="checkbox"/>	E2213 Flat-Free Inserts For 24"x1-3/8" Tires Only	 E2211/E2213 \$ 117

CASTERS					
SIZE	TIRE WIDTH	HUB COLOR	TIRE COLOR	DESCRIPTION	
<input type="checkbox"/> 3"	1"	Black Hub	Black Tire Only	Polyeurathane	\$ STD
<input type="checkbox"/> 3"	1"	Plastic Black Hub	Clear Tire Only	Lighted, Polyeurathane	\$ 65
<input type="checkbox"/> 3"	1"	Red Hub	Red Tire Only	Polyeurathane	\$ STD
<input type="checkbox"/> 3"	1"	Black Hub	Clear Tire Only	Polyeurathane	\$ STD
<input type="checkbox"/> 3"	1"	Aluminum Silver Hub	Black Tire Only	Made By Flog Legs	\$ 165
<input type="checkbox"/> 3"	1"	Aluminum Black Hub	Black Tire Only	Made By Flog Legs	\$ 165
<input type="checkbox"/> 3"	1.5"	Aluminum Silver Hub	Black Tire Only	Soft Roll Made By Flog Legs	\$ 165
<input type="checkbox"/> 3"	1.5"	Aluminum Black Hub	Black Tire Only	Soft Roll Made By Flog Legs	\$ 165
<input type="checkbox"/> 4"	1"	Plastic Black Hub	Black Tire Only		\$ STD
<input type="checkbox"/> 4"	1"	Plastic Black Hub	Clear Only	Lighted, Polyeurathane	\$ 65
<input type="checkbox"/> 4"	1"	Plastic Black Hub	Black Tire Only	Made By Flog Legs	\$ 125
<input type="checkbox"/> 4"	1"	Aluminum Silver Hub	Black Tire Only	Made By Flog Legs	\$ 165
<input type="checkbox"/> 4"	1"	Aluminum Black Hub	Black Tire Only	Made By Flog Legs	\$ 165
<input type="checkbox"/> 4"	1.5"	Composite Black Hub	Tire <input type="checkbox"/> Black <input type="checkbox"/> Blue <input type="checkbox"/> Red	Soft Roll Made By Flog Legs	\$ 135
<input type="checkbox"/> 4"	1.5"	Aluminum Silver Hub	Tire <input type="checkbox"/> Black <input type="checkbox"/> Blue <input type="checkbox"/> Red	Soft Roll Made By Flog Legs	\$ 165
<input type="checkbox"/> 4"	1.5"	Aluminum Black Hub	Black Tire Only	Soft Roll Made By Flog Legs	\$ 165
<input type="checkbox"/> 5"	1"	Composite Black Hub	Black Tire Only		\$ STD
<input type="checkbox"/> 5"	1"	Plastic Black Hub	Clear Tire Only	Lighted, Polyeurathane	\$ 65
<input type="checkbox"/> 5"	1"	Composite Black Hub	Black Tire Only	Made By Flog Legs	\$ 125
<input type="checkbox"/> 5"	1"	Aluminum Silver Hub	Black Tire Only	Made By Flog Legs	\$ 165
<input type="checkbox"/> 5"	1"	Aluminum Black Hub	Black Tire Only	Made By Flog Legs	\$ 165
<input type="checkbox"/> 5"	1.5"	Composite Black Hub	Tire <input type="checkbox"/> Black <input type="checkbox"/> Blue <input type="checkbox"/> Red	Soft Roll Made By Flog Legs	\$ 135
<input type="checkbox"/> 5"	1.5"	Aluminum Silver Hub	Tire <input type="checkbox"/> Black <input type="checkbox"/> Blue <input type="checkbox"/> Red	Soft Roll Made By Flog Legs	\$ 165
<input type="checkbox"/> 5"	1.5"	Aluminum Black Hub	Black Tire Only	Soft Roll Made By Flog Legs	\$ 165

FORKS			
<input type="checkbox"/>	STD Aluminum Forks	Black Only \$ STD
	Extra Options for Aluminum Forks	<input type="checkbox"/> With Suspension Springs E1015 \$ 55
		<input type="checkbox"/> With Quick Release Axles K0073 \$ 107
<input type="checkbox"/>	Frog Leg Suspension Forks Std 1" Wide	(For 3", 4" x 1" width Caster and 5" STD Caster, 5" lighted Caster)	(Not available with Quick Release Axles)
	Color	<input type="checkbox"/> Anodized Black <input type="checkbox"/> Anodized Silver E1015 \$ 575
<input type="checkbox"/>	Frog Leg Suspension Forks 1.5" Wide	(For 3", 4" x 1.5" width Caster and 5" x 1"& 5" x 1.5" Casters)	(Not available with Quick Release Axles)
	Color	<input type="checkbox"/> Anodized Black <input type="checkbox"/> Anodized Silver E1015 \$ 575

Sub Total Section C 1/2	\$
Sub Total Section C 2/2	\$
Total Section C	\$

D COMPONENTS

WHEEL LOCKS		
<input type="checkbox"/> Push to Lock / Anodized Black Only		\$ STD
<input type="checkbox"/> NEW Compact Push to Lock / Anodized Black Only <input type="checkbox"/> w/ 2" Extension Handle (\$65up)		\$ 110
<input type="checkbox"/> NEW Compact Scissor Lock / Anodized Black Only		\$ 110
<input type="checkbox"/> D's Locks (*Not available with X-Core, Topolino WX2.5, Pro Wheels, Magic wheels) (*Does not include installation fee)		\$ CFP
PUSH HANDLES *If you are ordering push handles, You must select the backrest locking mechanism.		
<input type="checkbox"/> Integrated w/Fixed Backrest Height / Anodized Black Only		\$ STD
<input type="checkbox"/> Bolt-on / Anodized Black Only Specify Height from floor -()		\$ 142
<input type="checkbox"/> Bolt-on w/Quick Release / Anodized Black Only Specify Height from floor -()		\$ 190
<input type="checkbox"/> NEW Height Adj. / Anodized Black Only Specify Maximum height from floor -()		\$ 295
NEW ARM RESTS Anodized Black Only,		
<input type="checkbox"/> Fixed Tubular Armrest Adj. Angle and Height Height from seat sling Set at : <input type="checkbox"/> 8" <input type="checkbox"/> 9" <input type="checkbox"/> 10" <input type="checkbox"/> 11" <input type="checkbox"/> 12" E0973		\$ 250
<input type="checkbox"/> Swing Away Tubular Armrest Adj. Angle and Height Height from seat sling Set at : <input type="checkbox"/> 8" <input type="checkbox"/> 9" <input type="checkbox"/> 10" <input type="checkbox"/> 11" <input type="checkbox"/> 12" E0973		\$ 250
<input type="checkbox"/> Flip-Up Armrest <input type="checkbox"/> w/Fixed Tubular Armrest Height from seat sling Set at : <input type="checkbox"/> 8" <input type="checkbox"/> 9" <input type="checkbox"/> 10" <input type="checkbox"/> 11" <input type="checkbox"/> 12" E0973		\$ 250
Adj. Angle <input type="checkbox"/> w/ Swing Away Tubular Armrest Height from seat sling Set at : <input type="checkbox"/> 8" <input type="checkbox"/> 9" <input type="checkbox"/> 10" <input type="checkbox"/> 11" <input type="checkbox"/> 12" E0973		\$ 250
<input type="checkbox"/> Custom Length & Height (\$150 up charge) *Specify Height & Length →		
ANTI-TIPPERS		
<input type="checkbox"/> Anti-Tippers (pair) w/ Quick Release / Anodized Black Only		E0971 \$ 112
SIDE GUARDS		
<input type="checkbox"/> Rigid Side Guards - Black ABS <input type="checkbox"/> Non-Removable <input type="checkbox"/> Removable <input type="checkbox"/> Removable w/Hole (\$10 up charge)		\$ 142
	Size: <input type="checkbox"/> STD <input type="checkbox"/> Medium <input type="checkbox"/> Cut to Wheel (\$98 up charge) Measurement	
	Color: Black Only	
<input type="checkbox"/> Rigid Side Guards - Aluminum <input type="checkbox"/> Non-Removable <input type="checkbox"/> Removable		\$ 197
	Size: <input type="checkbox"/> Medium Only <input type="checkbox"/> Cut to Wheel (\$98 up charge) Measurement	
	Color <input type="checkbox"/> Black (STD) <input type="checkbox"/> Pol. Aluminum (STD)	
	<input type="checkbox"/> Powder Coated () (\$50 up charge)	
	<input type="checkbox"/> Gold Plate (+CFP)	
<input type="checkbox"/> PRO-TEX Fender Guards / (Black ABS -Only) <input type="checkbox"/> Cut to Fit Specs <input type="checkbox"/> Do Not Install		\$ 175
<input type="checkbox"/> Fabric Clothing Guards Black Nylon w/Velcro		\$ 78
SEAT CUSHION -*Please see section E for other cushion choices.-		
<input type="checkbox"/> Foam Cushion w/Nylon Black Cover Thickness <input type="checkbox"/> 1" <input type="checkbox"/> 2" <input type="checkbox"/> 3" <input type="checkbox"/> 4"		\$ 78
<input type="checkbox"/> Custom Cushion Cover (Std. Foam Cushion Only) -Select Fabric ()		(\$90 up charge)
MISCELLANEOUS		
<input type="checkbox"/> Frame Protectors / Black Leather/Zipper Type		\$ 78
<input type="checkbox"/> K0065 Spoke Protectors / Black Only <input type="checkbox"/> 24" <input type="checkbox"/> 25" <input type="checkbox"/> 26"		K0065 \$ 107
<input type="checkbox"/> E0978 Seat Belt w/Auto Buckle (BP) 1.5" Black Belt Only		E0978 \$ 69
<input type="checkbox"/> Tie Down Brackets 4pcs.		\$ 210
SPECIALTY PARTS <input type="checkbox"/> Wheelchair Tray Size: <input type="checkbox"/> W14"x D12" <input type="checkbox"/> W16"x D14" <input type="checkbox"/> W18"x D14"		
	Color: <input type="checkbox"/> Raw Alum. <input type="checkbox"/> Black Alum. <input type="checkbox"/> Polish Alum. (\$250 up charge)	\$ 250
UPHOLSTERY CHOICE & COLOR *Positioning Back Available. Please see Section E		
<input type="checkbox"/> Standard Adjustable Ht Backrest Black Only		\$ STD
<input type="checkbox"/> Adjustable Tension Backrest Black Only (*Not available with 8" Backrest Height)		\$ 135
Custom Options <input type="checkbox"/> Fabrics for Fun <input type="checkbox"/> 001 <input type="checkbox"/> 002 <input type="checkbox"/> 003 <input type="checkbox"/> 004 <input type="checkbox"/> 006 <input type="checkbox"/> 010 <input type="checkbox"/> 011		(\$95 up charge)
	For Std. or Adj. Style <input type="checkbox"/> 014 <input type="checkbox"/> 015 <input type="checkbox"/> 016 <input type="checkbox"/> 017 <input type="checkbox"/> 018 <input type="checkbox"/> 020 <input type="checkbox"/> 021	
	<input type="checkbox"/> 022 <input type="checkbox"/> 023 <input type="checkbox"/> 024 <input type="checkbox"/> 025 <input type="checkbox"/> 026 <input type="checkbox"/> 027 <input type="checkbox"/> 028	
<input type="checkbox"/> Backrest Leather Trim (outside panels)		(\$77 up charge)
<input type="checkbox"/> Calf Strap <input type="checkbox"/> Black <input type="checkbox"/> Matching Fabric (\$55 up charge) -Select Fabric()		K0038 \$ 24
<input type="checkbox"/> Matching Fabric on Padded Side Guards -Select Fabric ()		\$ 210
Total Section D \$		

E CHAIR OPTIONS 1/2

SEAT CUSHION							
SUPRACOR® WHEELCHAIR CUSHIONS							
Stimulite® Contoured Cushion *Black Upholstery only	<input type="checkbox"/> W14"xD16" (CD1416)	E2603 \$ 525				
	<input type="checkbox"/> W16"xD16" (CD1616)	E2603 \$ 525				
	<input type="checkbox"/> W16"xD18" (CD1618)	E2603 \$ 525				
	<input type="checkbox"/> W18"xD16" (CD1816)	E2603 \$ 525				
	<input type="checkbox"/> W18"xD18" (CD1818)	E2603 \$ 525				
	<input type="checkbox"/> W18"xD20" (CD1820)	E2603 \$ 540				
	<input type="checkbox"/> W20"xD16" (CD2016)	E2603 \$ 540				
	<input type="checkbox"/> W20"xD18" (CD2018)	E2603 \$ 540				
	<input type="checkbox"/> W20"xD20" (CD2020)	E2603 \$ 555				
			<input type="checkbox"/> Extra Sensitive (\$30 up charge) <input type="checkbox"/> Sling Style Bottom (\$45 up charge) <input type="checkbox"/> Custom Size W(") x D(") (-\$ CFP)				
Stimulite® Slimline Cushion *Black Upholstery only	<input type="checkbox"/> W14"xD16" (SM1416)	E2603 \$ 495				
	<input type="checkbox"/> W16"xD16" (SM1616)	E2603 \$ 495				
	<input type="checkbox"/> W16"xD18" (SM1618)	E2603 \$ 495				
	<input type="checkbox"/> W18"xD18" (SM1818)	E2603 \$ 495				
	<input type="checkbox"/> W18"xD20" (SM1820)	E2603 \$ 495				
	<input type="checkbox"/> W20"xD16" (SM2016)	E2603 \$ 510				
	<input type="checkbox"/> W20"xD18" (SM2018)	E2603 \$ 510				
	<input type="checkbox"/> W20"xD20" (SM2020)	E2603 \$ 510				
			<input type="checkbox"/> Extra Sensitive (\$30 up charge) <input type="checkbox"/> Sling Style Bottom (\$45 up charge) <input type="checkbox"/> Custom Size W(") x D(") (-\$ CFP)				
	Stimulite® Corbee Pediatric *Black Upholstery only	<input type="checkbox"/> W10"xD10" (PD1010)	E2603 \$ 450			
<input type="checkbox"/> W12"xD12" (PD1212)		E2603 \$ 450				
<input type="checkbox"/> W14"xD14" (PD1414)		E2603 \$ 450				
		<input type="checkbox"/> Extra Sensitive (\$30 up charge) <input type="checkbox"/> Sling Style Bottom (\$45 up charge) <input type="checkbox"/> Custom Size W(") x D(") (-\$ CFP)					
ROHO WHEELCHAIR CUSHIONS							
<input type="checkbox"/> 4" HIGH PROFILE® QUADTRO SELECT® CUSHION Choose Size	<input type="checkbox"/> W12"xD12" <input type="checkbox"/> W12"xD13" <input type="checkbox"/> W13"xD13" <input type="checkbox"/> W13"xD15" <input type="checkbox"/> W13"xD16" <input type="checkbox"/> W15"xD13" <input type="checkbox"/> W15"xD15"		*Black Upholstery E2622-2623 \$ 525 <input type="checkbox"/> Custom Size W(") x D(") (+\$85)				
	<input type="checkbox"/> W15"xD16" <input type="checkbox"/> W15"xD18" <input type="checkbox"/> W16"xD15" <input type="checkbox"/> W16"xD16" <input type="checkbox"/> W16"xD18" <input type="checkbox"/> W16"xD20" <input type="checkbox"/> W18"xD15"						
	<input type="checkbox"/> W18"xD16" <input type="checkbox"/> W18"xD18" <input type="checkbox"/> W18"xD20" <input type="checkbox"/> W18"xD22" <input type="checkbox"/> W20"xD16" <input type="checkbox"/> W20"xD18" <input type="checkbox"/> W20"xD20"						
	<input type="checkbox"/> W20"xD22" <input type="checkbox"/> W22"xD18" <input type="checkbox"/> W22"xD20" <input type="checkbox"/> W22"xD22"						
<input type="checkbox"/> 3" MID PROFILE® QUADTRO SELECT® CUSHION Choose Size	<input type="checkbox"/> W15"xD15" <input type="checkbox"/> W15"xD16" <input type="checkbox"/> W16"xD16" <input type="checkbox"/> W16"xD18" <input type="checkbox"/> W18"xD16" <input type="checkbox"/> W18"xD18"		*Black Upholstery only E2622-2623 \$ 525 <input type="checkbox"/> Custom Size W(") x D(") (+\$85)				
<input type="checkbox"/> 2" LOW PROFILE® QUADTRO SELECT® CUSHION Choose Size	<input type="checkbox"/> W12"xD12" <input type="checkbox"/> W12"xD13" <input type="checkbox"/> W13"xD13" <input type="checkbox"/> W13"xD15" <input type="checkbox"/> W13"xD16" <input type="checkbox"/> W15"xD13" <input type="checkbox"/> W15"xD15"		*Black Upholstery only E2622-2623 \$ 525 <input type="checkbox"/> Custom Size W(") x D(") (+\$85)				
	<input type="checkbox"/> W15"xD16" <input type="checkbox"/> W15"xD18" <input type="checkbox"/> W16"xD15" <input type="checkbox"/> W16"xD16" <input type="checkbox"/> W16"xD18" <input type="checkbox"/> W16"xD20" <input type="checkbox"/> W18"xD15"						
	<input type="checkbox"/> W18"xD16" <input type="checkbox"/> W18"xD18" <input type="checkbox"/> W18"xD20" <input type="checkbox"/> W20"xD16" <input type="checkbox"/> W20"xD18" <input type="checkbox"/> W20"xD20"						
	<input type="checkbox"/> Custom Size W(") x D(") (+\$85)						
<input type="checkbox"/> 2" NEXUS SPIRIT® CUSHION Choose Size	<input type="checkbox"/> W14"xD14" <input type="checkbox"/> W14"xD16" <input type="checkbox"/> W15"xD15" <input type="checkbox"/> W16"xD16" <input type="checkbox"/> W16"xD18" <input type="checkbox"/> W17"xD17" <input type="checkbox"/> W18"xD16"		*Black Upholstery only E2622 \$ 525 * Custom Size Not Available				
	<input type="checkbox"/> W18"xD18" <input type="checkbox"/> W20"xD18"						
STAR CUSHIONS							
Galaxy Cushion *Black Upholstery only	<input type="checkbox"/> W14"xD14" (GXY 1414-2) <input type="checkbox"/> W14"xD16" (GXY 1416-2) <input type="checkbox"/> W16"xD14" (GXY 1614-2) <input type="checkbox"/> W16"xD16" (GXY 1616-2) <input type="checkbox"/> W16"xD18" (GXY 1618-2) <input type="checkbox"/> W18"xD16" (GXY 1816-2) ⇒ <input type="checkbox"/> W18"xD18" (GXY 1818-2) <input type="checkbox"/> W18"xD20" (GXY 1820-2) <input type="checkbox"/> W20"xD16" (GXY 2016-2) <input type="checkbox"/> W20"xD18" (GXY 2018-2) <input type="checkbox"/> W20"xD20" (GXY 2020-2)		Choose Zoning Options E2624 \$ 498 <input type="checkbox"/> Standard - Dual Valve <input type="checkbox"/> Dual Valve - Front to Back <input type="checkbox"/> Four Valve <input type="checkbox"/> Simple - Single Valve <input type="checkbox"/> Four Valve - Enhanced <input type="checkbox"/> Four Valve - Front to Back				
THE CURVE CUSHION *Black Upholstery only	<input type="checkbox"/> W10"xD10"	<input type="checkbox"/> W10"xD11"	<input type="checkbox"/> W10"xD11"	<input type="checkbox"/> W10"xD12"	<input type="checkbox"/> W11"xD12"	<input type="checkbox"/> W12"xD12"	\$ 133
	<input type="checkbox"/> W12"xD13"	<input type="checkbox"/> W12"xD14"	<input type="checkbox"/> W13"xD11"	<input type="checkbox"/> W13"xD12"	<input type="checkbox"/> W13"xD13"	<input type="checkbox"/> W13"xD14"	
	<input type="checkbox"/> W14"xD14"	<input type="checkbox"/> W14"xD15"	<input type="checkbox"/> W14"xD16"	<input type="checkbox"/> W15"xD14"	<input type="checkbox"/> W15"xD15"	<input type="checkbox"/> W15"xD16"	
	<input type="checkbox"/> W16"xD14"	<input type="checkbox"/> W16"xD15"	<input type="checkbox"/> W16"xD16"	<input type="checkbox"/> W16"xD17"	<input type="checkbox"/> W16"xD18"	<input type="checkbox"/> W17"xD16"	
	<input type="checkbox"/> W17"xD17"	<input type="checkbox"/> W17"xD18"	<input type="checkbox"/> W18"xD16"	<input type="checkbox"/> W18"xD17"	<input type="checkbox"/> W18"xD18"		
NOTE							

E CHAIR OPTIONS 2/2

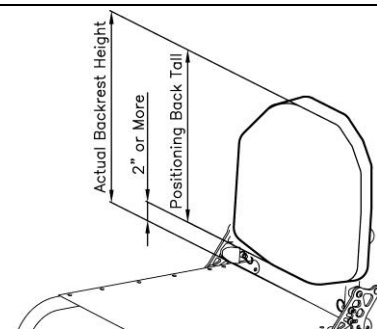
POSITIONING BACK			
<p>*Note : Actual height of the backrest will increase 2" or more.</p> 			
<p>ADI CARBON BACKREST (Support Contour-ACTIVE 2.5") *Not Available with Welded Side Guards</p> <p>Mounting Hardware: <input type="checkbox"/> 2 Point Pro <input type="checkbox"/> Quick Release</p>			
Height	<input type="checkbox"/> LOW (10" Tall) *Backrest Height requires 12" or more *Available 13"-19" width Width (") E2613 \$ 745 <input type="checkbox"/> Medium (13" Tall) *Backrest Height requires 15" or more *Available 13"-19" width Width (") E2613 \$ 815 <input type="checkbox"/> Standard (16" Tall) *Backrest Height requires 18" or more *Available 13"-19" width Width (") E2613 \$ 880 <input type="checkbox"/> Custom Size (" Tall) x (" width) E2613 \$ CFP		
<p>ADI ALUMINUM BACKREST (Support Contour-ACTIVE 2.5") *Not Available with Welded Side Guards</p> <p>Mounting Hardware: <input type="checkbox"/> 2 Point Pro <input type="checkbox"/> Quick Release</p>			
Height	<input type="checkbox"/> LOW (10" Tall) *Backrest Height requires 12" or more *Available 10"-20" width Width (") E2613 \$ 610 <input type="checkbox"/> Medium (13" Tall) *Backrest Height requires 15" or more *Available 12"-20" width Width (") E2613 \$ 625 <input type="checkbox"/> Standard (16" Tall) *Backrest Height requires 18" or more *Available 14"-20" width Width (") E2613 \$ 640 <input type="checkbox"/> Tall (18" Tall) *Backrest Height requires 20" or more *Available 16"-20" width Width (") E2613 \$ 655 <input type="checkbox"/> X-Tall (20" Tall) *Backrest Height requires 22" or more *Available 16"-20" width Width (") E2613 \$ 670 <input type="checkbox"/> Custom Size (" Tall) x (" width) E2613 \$ CFP		
<p>ADI ALUMINUM BACKREST (Support Contour-DEEP 4") *Not Available with Welded Side Guards *Not Available with Lateral Supports</p> <p>Mounting Hardware: <input type="checkbox"/> 2 Point Pro <input type="checkbox"/> Quick Release</p>			
Height	<input type="checkbox"/> LOW (10" Tall) *Backrest Height requires 12" or more *Available 10"-20" width Width (") E2615 \$ 710 <input type="checkbox"/> Medium (13" Tall) *Backrest Height requires 15" or more *Available 12"-20" width Width (") E2615 \$ 725 <input type="checkbox"/> Standard (16" Tall) *Backrest Height requires 18" or more *Available 14"-20" width Width (") E2615 \$ 740 <input type="checkbox"/> Tall (18" Tall) *Backrest Height requires 20" or more *Available 16"-20" width Width (") E2615 \$ 755 <input type="checkbox"/> X-Tall (20" Tall) *Backrest Height requires 22" or more *Available 16"-20" width Width (") E2615 \$ 770 <input type="checkbox"/> Custom Size (" Tall) x (" width) E2615 \$ CFP		
<p>ADI LATERAL SUPPORTS (Lateral Supports are compatible with only active 2.5" ADI positioning back.)</p> <p><input type="checkbox"/> Stationary Pad Pad Size <input type="checkbox"/> Small (3" H x 3" D) <input type="checkbox"/> Medium(3" H x 4" D) <input type="checkbox"/> Large(4.5" H x 4.5" D) <input type="checkbox"/> Large(4" H x 6" D)</p> <p> <input type="checkbox"/> Pair \$ 320</p> <p> <input type="checkbox"/> Left side only or <input type="checkbox"/> Right side only \$ 160</p> <p><input type="checkbox"/> Swing-Out Pad Size <input type="checkbox"/> Small (3" H x 3" D) <input type="checkbox"/> Medium(3" H x 4" D) <input type="checkbox"/> Large(4.5" H x 4.5" D) <input type="checkbox"/> Large(4" H x 6" D)</p> <p> <input type="checkbox"/> Pair \$ 520</p> <p> <input type="checkbox"/> Left side only or <input type="checkbox"/> Right side only \$ 260</p>			
OTHER			
<input type="checkbox"/> ADI Transfer Board <input type="checkbox"/> 21" (ADV21) <input type="checkbox"/> 24" (ADV24) <input type="checkbox"/> 29" \$ 62			
<input type="checkbox"/> ADI Push and Transfer Gloves Leather (one size fits) \$ 60			
<input type="checkbox"/> ADI Carbon Solid Seat (Wide: 18" Max, Depth: 20") *Colours Side Guards Not Available with ADI Carbon Solid Seat \$ 625			
With / <input type="checkbox"/> ADI Folding Carbon Side Guard \$ 400			
With / <input type="checkbox"/> ADI Fixed Carbon Side Guard \$ 375			
<p>VARILITE® Seating Systems Available</p> <p style="text-align: right;">Please visit for all options. www.varilite.com</p>			CFP
NOTE			
		Sub Total Section E 1/2	\$
		Sub Total Section E 2/2	\$
		Total Section E	\$

1. SEAT WIDTH

Measure from outside of seat tube to the outside of the opposite seat tube.

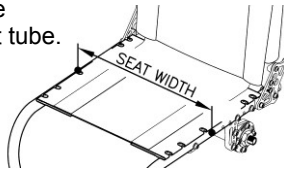

2. SEAT DEPTH

Measure from at the front bottom of backrest tube to the front edge of seat sling.

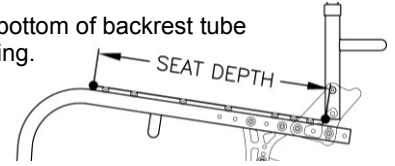

3. FOOTREST WIDTH

Measure from inside of front frame tube to inside of opposite front frame tube.

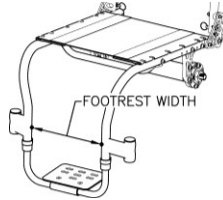

4. FRAME ANGLE

Measure angle frame front to floor.

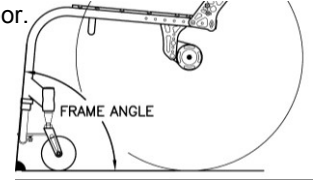

5. BACKREST HEIGHT

Measure from top of back post to seat sling at front bottom of backrest tube.

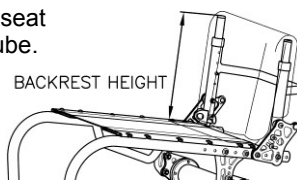

6. BACKREST ANGLE

Measure angle from front of back post to floor.

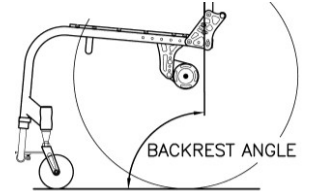

7. FRONT SEAT HEIGHT

Measure from floor to top of seat sling at front edge.

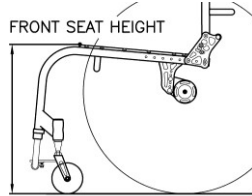

8. REAR SEAT HEIGHT

Measure from floor to top of seat sling at front bottom of backrest tube.

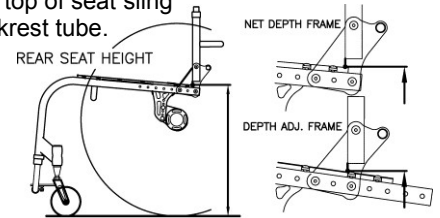

9. CENTER OF GRAVITY

Measure from center of back tube at the folding pivot to the center of the rear axle.

(If welding backrest is selected, Measure from center of back tube at the seat tube to the center of the rear axle.)

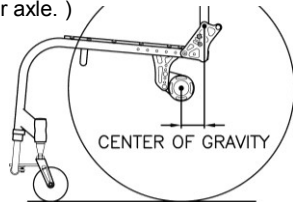

10. CAMBER ANGLE

Measure angle from wheel to vertical at floor.

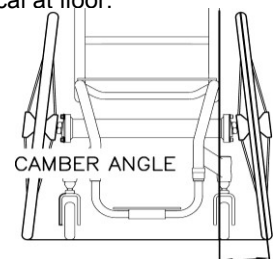

11. FRONT OF SEAT SLING TO FOOTREST

ADULT CHAIR

Measure from top of seat sling at front edge to top of foot plate at front edge.

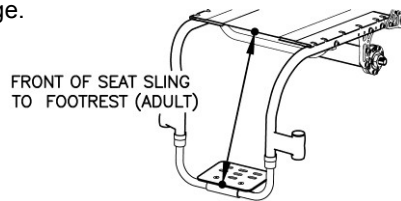

PEDIATRIC CHAIR

Measure vertical from top of seat sling at front edge to top of foot plate.



12. INSIDE WHEEL CLEARANCE

Measure from outside of seat back tube to inside of rear tire.

(If side guards are selected, measure from outside of side guards to inside of rear tire.)

