

DEALER			COLOURS INFORMATION For Office Use Only		
Dealer:			Order Date:		S/N:
Account:		P.O.#:	<b>RTS</b>		
Ordered By:			RTS:		Phone:
Address:			Email:		
City:		State:	Zip:		<b>SHIP TO</b>
Phone:		Fax:	Name:		Ship Via:
Email:			Address:		
Customer Name:		State:	City:		Zip:
Customer Weight:			Phone:		Fax:

CHAIR INFORMATION	PRICE
<b>SPAZZ K0005</b>	Base Wheel Chair Price <b>K0005</b> \$ 2,400
<b>Adjustable FSH-RSH</b>	Total Section <b>A</b> \$
<b>Max. Capacity 250Lbs</b>	Total Section <b>B</b> \$
<b>NOTE</b>	Total Section <b>C</b> \$
<b>Main Frame : ZK55 &amp; ZK60 High Grade A7000 Series Aluminum</b>	Total Section <b>D</b> \$
<b>Main Frame : Lifetime Warranty</b>	Total Section <b>E</b> \$
*See warranty policy	Total Section <b>F (Custom Parts Color)</b> \$
	<b>ORDER GRAND TOTAL</b> \$

**A FRAME COLORS & PARTS COLORS**

FRAME COLORS		
<b>Powder-Coa</b>	<input type="checkbox"/> Gloss Black <input type="checkbox"/> Twilight Flake <input type="checkbox"/> Yellow <input type="checkbox"/> Magenta <input type="checkbox"/> Fire Engine Red <input type="checkbox"/> White <input type="checkbox"/> Candy Blue <input type="checkbox"/> Candy Purple <input type="checkbox"/> Candy Green <input type="checkbox"/> Candy Red <input type="checkbox"/> Candy Raspberry <input type="checkbox"/> Cobalt Blue <input type="checkbox"/> Matte Gray <input type="checkbox"/> Matte Purple <input type="checkbox"/> Matte Blue <input type="checkbox"/> Matte Green <input type="checkbox"/> Matte Black <input type="checkbox"/> Matte Red <input type="checkbox"/> Neon Red <input type="checkbox"/> Neon Green <input type="checkbox"/> Orange Sparkle <input type="checkbox"/> Mellon Yellow <input type="checkbox"/> Gun Smoke Silver <input type="checkbox"/> Pigeon Blue <input type="checkbox"/> Granny Sparkle Green <input type="checkbox"/> Sparkle Sky Blue <input type="checkbox"/> Vermilion <input type="checkbox"/> Reed Green <input type="checkbox"/> Blue Lilac	\$ STD
<b>Special</b>	<input type="checkbox"/> Polished ..... <input type="checkbox"/> 24 karat Gold Plated .....	\$ 800 \$ CFP

PARTS COLORS (Custom Parts Color Section, Please see Section F)		
<b>STD Color</b>	Black Color (*Suspension Springs-Silver Color)	\$ STD
<b>Custom Color Main Bolt on Parts One Color Package</b>	<input type="checkbox"/> Powder-Coated ( ) .. <input type="checkbox"/> Polished ..... <input type="checkbox"/> 24 karat Gold Plated .....	\$ 500 \$ 750 \$ CFP
Including: Backrest, Foot Plate, Footrest Rings, Backrest Brackets, Saddle Stops, Forks & Knurl Nuts, Caps, Front Suspension Springs, Axle Tube, Axle Clamps, Axle Plates, Axle Bases, Camber Discs, Caster Housings ☆marked parts		

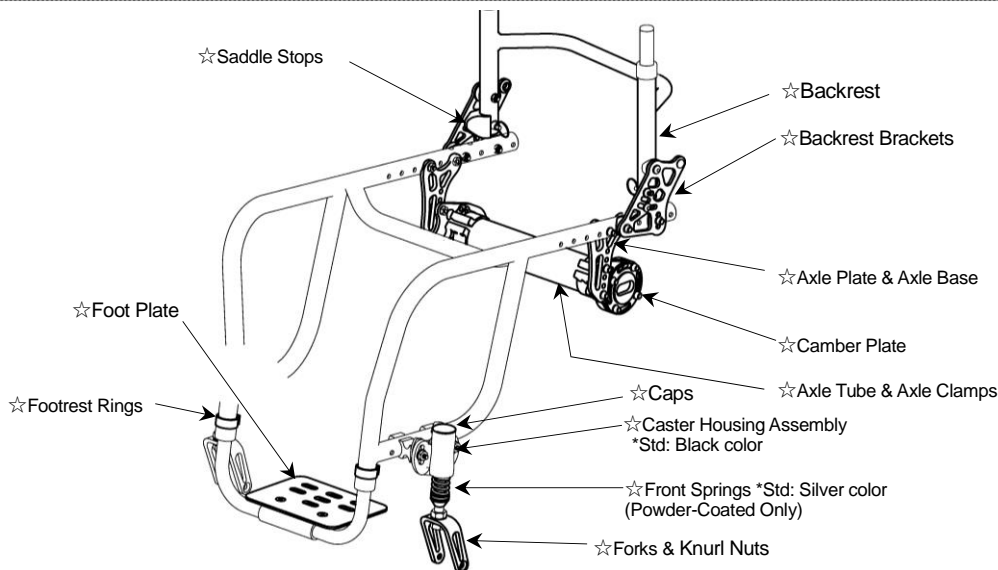

**Total Section A \$**

## B FRAME MEASUREMENTS 1/2

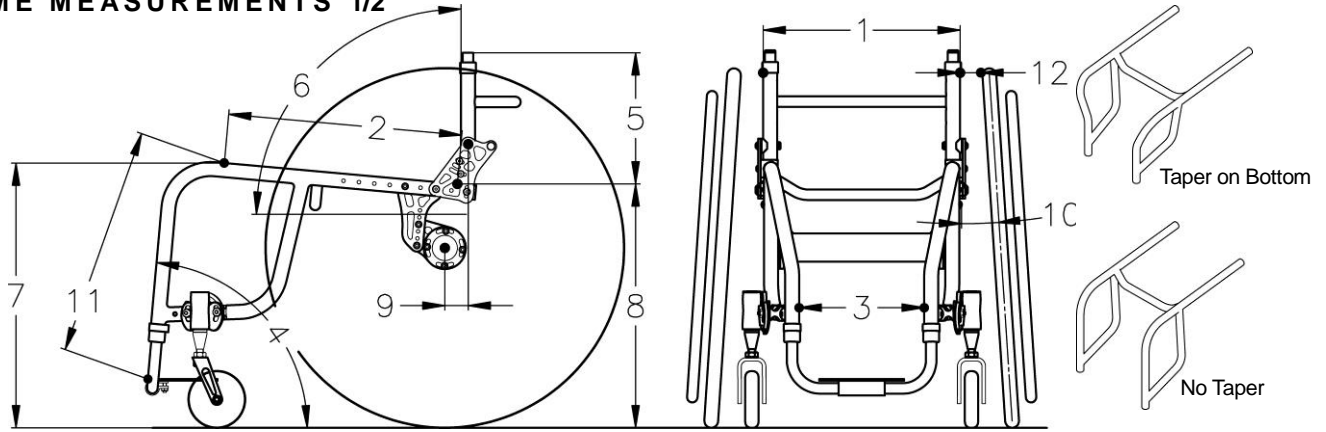

<b>FRAME</b>	<input type="checkbox"/> STD Frame (Max. Capacity 250Lbs) .....	\$ STD								
	<input type="checkbox"/> Heavy Duty Frame (Max. Capacity 300Lbs) .....	\$ 750								
<b>1. SEAT WIDTH</b>	<input type="checkbox"/> 14" <input type="checkbox"/> 15" <input type="checkbox"/> 16" <input type="checkbox"/> 17" <input type="checkbox"/> 18" .....	\$ STD								
	<input type="checkbox"/> 19" <input type="checkbox"/> 20" .....	\$ 284								
<b>2. SEAT DEPTH</b> * Only Choose One Option	<input type="checkbox"/> Net Seat Depth <input type="checkbox"/> 13" <input type="checkbox"/> 14" <input type="checkbox"/> 15" <input type="checkbox"/> 16" <input type="checkbox"/> 17" <input type="checkbox"/> 18" <input type="checkbox"/> 19" .....	\$ STD								
	<input type="checkbox"/> Net Seat Depth <input type="checkbox"/> 20" .....	<b>E2203</b> \$ 250								
	<input type="checkbox"/> Depth Adj. Frame <input type="checkbox"/> Short Frame (16" Depth) Set at <input type="checkbox"/> 13" <input type="checkbox"/> 14" <input type="checkbox"/> 15" <input type="checkbox"/> 16" ...	\$ STD								
	<input type="checkbox"/> Depth Adj. Frame <input type="checkbox"/> Long Frame (19" Depth) Set at <input type="checkbox"/> 16" <input type="checkbox"/> 17" <input type="checkbox"/> 18" <input type="checkbox"/> 19" ...	\$ STD								
	<input type="checkbox"/> Positioning Frame Add (            ") .....	\$ 150								
<b>3. FOOTREST WIDTH</b>	<input type="checkbox"/> STD (Seat Width Minus 5", Taper on Bottom Frame) .....	\$ STD								
	<input type="checkbox"/> Custom (            ") Taper on Bottom Only .....	\$ 150								
	<input type="checkbox"/> No Taper (Seat Width Minus .....	\$ NCO								
<b>FOOT PLATE STYLE</b>	<input type="checkbox"/> Standard single loop with adjust. height & angle. STD Foot Plate .....	<b>K0040</b> \$ STD								
	<input type="checkbox"/> Single Flip-Back-single loop (no riser avail) with adjust. height & angle. STD Foot Plate .....	<b>K0040</b> \$ 150								
<b>STD Foot Plate Size Chart</b>	<table border="1"> <thead> <tr> <th>Your Footrest Width</th> <th>Foot Plate Size</th> </tr> </thead> <tbody> <tr> <td>8.5"-10.5"</td> <td>W6.5"xD5"</td> </tr> <tr> <td>11.0"-13.0"</td> <td>W8.5"xD6.5"</td> </tr> <tr> <td>13.5"-17.0"</td> <td>W11"xD6.5"</td> </tr> </tbody> </table>	Your Footrest Width	Foot Plate Size	8.5"-10.5"	W6.5"xD5"	11.0"-13.0"	W8.5"xD6.5"	13.5"-17.0"	W11"xD6.5"	
	Your Footrest Width	Foot Plate Size								
8.5"-10.5"	W6.5"xD5"									
11.0"-13.0"	W8.5"xD6.5"									
13.5"-17.0"	W11"xD6.5"									
<b>CUSTOM FOOT PLATE</b>	<input type="checkbox"/> Custom Foot Plate. with adjust. height & angle .....	<b>K0040</b> \$ 75								
	*Available Solid Plate Only <input type="checkbox"/> Drill 2Sets Extra Holes in Footplate									
	<input type="checkbox"/> Custom Tubular Footrest .....	\$ 250								
<b>4. FRAME ANGLE</b>	<input type="checkbox"/> 75° <input type="checkbox"/> 80° <input type="checkbox"/> 85° <input type="checkbox"/> 90° to the ground .....	\$ STD								
	<input type="checkbox"/> Custom (            °) to the ground .....	\$ NCO								
	<input type="checkbox"/> With ABS Foot Plate (\$65 up charge)									

**B FRAME MEASUREMENTS 2/2**

<b>5. BACKREST HEIGHT</b> <small>* Rigidizer bar 3.25" deep std.</small>	<input type="checkbox"/> 8" <input type="checkbox"/> 9" <input type="checkbox"/> 10" <input type="checkbox"/> 11" <input type="checkbox"/> 12" <input type="checkbox"/> 13" <input type="checkbox"/> 14" <input type="checkbox"/> 15" <input type="checkbox"/> 16" <input type="checkbox"/> 17" <input type="checkbox"/> 18"	Adj. Range	Adj. Range	Adj. Range	\$ STD
<b>Type</b>	<input type="checkbox"/> <b>Locking mechan.</b> with adjust. height & angle ..... \$ STD				
	<input type="checkbox"/> <b>Double Locking mechan.</b> with adjust. height & angle ..... \$ 25				
	<input type="checkbox"/> <b>Folding with adjust.</b> height & angle ..... \$ NCO				
	<input type="checkbox"/> <b>Welded Backrest</b> Angle Set at (        ") to the ground *Non Folding Backrest only ... \$ 150				
<b>CUSTOM</b>	<input type="checkbox"/> <b>Welded Side Guards</b> *Non Folding Backrest only ..... \$ 450				
	<input type="checkbox"/> <b>Custom Backrest</b> ..... \$ 150 (ie: double rigidizer bars, custom depth custom height, etc)				

<b>6. BACKREST ANGLE</b>	Set at (        °) to the ground *STD 90°	\$ STD
--------------------------	---	--------

<b>7. FRONT SEAT HEIGHT</b>	<input type="checkbox"/> 17.5" <input type="checkbox"/> 18.0" <input type="checkbox"/> 18.5" <input type="checkbox"/> 19.0" <input type="checkbox"/> 19.5" <input type="checkbox"/> 20.0" <input type="checkbox"/> 20.5" .....	\$ STD
-----------------------------	--	--------

Front Seat Height Ranges  
 \* = Not Available with Quick Release Caster Axle.

Your Casters & Forks	Front Seat Height						
	17.5"	18.0"	18.5"	19.0"	19.5"	20.0"	20.5"
3" Caster & STD Forks	<input type="checkbox"/>	<input type="checkbox"/>	<input type="checkbox"/>	<input type="checkbox"/>	<input type="checkbox"/>	<input type="checkbox"/>	<input type="checkbox"/>
3" Caster & Springs	<input type="checkbox"/>	<input type="checkbox"/>	<input type="checkbox"/>	<input type="checkbox"/>	<input type="checkbox"/>	<input type="checkbox"/>	<input type="checkbox"/>
3" Caster & Frog Legs	<input type="checkbox"/>	<input type="checkbox"/>	<input type="checkbox"/>	<input type="checkbox"/>	<input type="checkbox"/>	<input type="checkbox"/>	<input type="checkbox"/>
4" Caster & STD Forks	<input type="checkbox"/>	<input type="checkbox"/>	<input type="checkbox"/>	<input type="checkbox"/>	<input type="checkbox"/>	<input type="checkbox"/>	<input type="checkbox"/>
4" Caster & Springs	<input type="checkbox"/>	<input type="checkbox"/>	<input type="checkbox"/>	<input type="checkbox"/>	<input type="checkbox"/>	<input type="checkbox"/>	<input type="checkbox"/>
4" Caster & Frog Legs	<input type="checkbox"/>	<input type="checkbox"/>	<input type="checkbox"/>	<input type="checkbox"/>	<input type="checkbox"/>	<input type="checkbox"/>	<input type="checkbox"/>
5" Caster & STD Forks	<input type="checkbox"/>	<input type="checkbox"/>	<input type="checkbox"/>	<input type="checkbox"/>	<input type="checkbox"/>	<input type="checkbox"/>	<input type="checkbox"/>
5" Caster & Springs	<input type="checkbox"/>	<input type="checkbox"/>	<input type="checkbox"/>	<input type="checkbox"/>	<input type="checkbox"/>	<input type="checkbox"/>	<input type="checkbox"/>
5" Caster & Frog Legs	<input type="checkbox"/>	<input type="checkbox"/>	<input type="checkbox"/>	<input type="checkbox"/>	<input type="checkbox"/>	<input type="checkbox"/>	<input type="checkbox"/>

<b>8. REAR SEAT HEIGHT</b>	<input type="checkbox"/> 14.5" <input type="checkbox"/> 15.0" <input type="checkbox"/> 15.5" <input type="checkbox"/> 16.0" <input type="checkbox"/> 16.5" <input type="checkbox"/> 17.0" <input type="checkbox"/> 17.5" <input type="checkbox"/> 18.0" <input type="checkbox"/> 18.5" <input type="checkbox"/> 19" .....	\$ STD
----------------------------	---	--------

Rear Seat Height Ranges  
 \*No Custom Modifications

Rear Tire Size	Rear Seat Height
24"x1"(540)	14.5" - 18.0"
24"x1 3/8"(540)	15.0" - 18.0"
25"x1"(559)	15.5" - 18.0"
24"x2"(540)	15.5" - 18.5"
26"x1"(590)	15.5" - 19.0"
25"x1.95"(559)	16.0" - 19.0"

<b>9. CENTER OF GRAVITY</b>	<input type="checkbox"/> 1.0" <input type="checkbox"/> 1.5" <input type="checkbox"/> 2.0" <input type="checkbox"/> 2.5" <input type="checkbox"/> 3.0" <input type="checkbox"/> 3.5" <input type="checkbox"/> 4.0" <input type="checkbox"/> 4.5" <input type="checkbox"/> 5.0" <input type="checkbox"/> 5.5" .....	\$ STD
-----------------------------	---	--------

Center of Gravity Ranges  
 ☆ = Not Available Scissor Wheel Lock  
 ★ = Excludes 24" x 2", 26" x 1", 25" x 1.95" tires are selected.

		Your Center of Gravity									
		1.0"	1.5"	2.0"	2.5"	3.0"	3.5"	4.0"	4.5"	5.0"	5.5"
Your Seat Depth	13"	<input type="checkbox"/>	<input type="checkbox"/>	<input type="checkbox"/>	<input type="checkbox"/>	<input type="checkbox"/>	<input type="checkbox"/>	<input type="checkbox"/>	<input type="checkbox"/>	<input type="checkbox"/>	<input type="checkbox"/>
	14"	<input type="checkbox"/>	<input type="checkbox"/>	<input type="checkbox"/>	<input type="checkbox"/>	<input type="checkbox"/>	<input type="checkbox"/>	<input type="checkbox"/>	<input type="checkbox"/>	<input type="checkbox"/>	<input type="checkbox"/>
	15"	<input type="checkbox"/>	<input type="checkbox"/>	<input type="checkbox"/>	<input type="checkbox"/>	<input type="checkbox"/>	<input type="checkbox"/>	<input type="checkbox"/>	<input type="checkbox"/>	<input type="checkbox"/>	<input type="checkbox"/>
	16"	<input type="checkbox"/>	<input type="checkbox"/>	<input type="checkbox"/>	<input type="checkbox"/>	<input type="checkbox"/>	<input type="checkbox"/>	<input type="checkbox"/>	<input type="checkbox"/>	<input type="checkbox"/>	<input type="checkbox"/>
	17"	<input type="checkbox"/>	<input type="checkbox"/>	<input type="checkbox"/>	<input type="checkbox"/>	<input type="checkbox"/>	<input type="checkbox"/>	<input type="checkbox"/>	<input type="checkbox"/>	<input type="checkbox"/>	<input type="checkbox"/>
	18"	<input type="checkbox"/>	<input type="checkbox"/>	<input type="checkbox"/>	<input type="checkbox"/>	<input type="checkbox"/>	<input type="checkbox"/>	<input type="checkbox"/>	<input type="checkbox"/>	<input type="checkbox"/>	<input type="checkbox"/>
	19"	<input type="checkbox"/>	<input type="checkbox"/>	<input type="checkbox"/>	<input type="checkbox"/>	<input type="checkbox"/>	<input type="checkbox"/>	<input type="checkbox"/>	<input type="checkbox"/>	<input type="checkbox"/>	<input type="checkbox"/>
	20"	<input type="checkbox"/>	<input type="checkbox"/>	<input type="checkbox"/>	<input type="checkbox"/>	<input type="checkbox"/>	<input type="checkbox"/>	<input type="checkbox"/>	<input type="checkbox"/>	<input type="checkbox"/>	<input type="checkbox"/>

<b>10. CAMBER ANGLE</b>	<input type="checkbox"/> 2° <input type="checkbox"/> 4° <input type="checkbox"/> 6° .....	\$ STD
-------------------------	---	--------

<b>11. FRONT OF SEAT SLING TO FRONT OF FOOTREST</b>	<input type="checkbox"/> 15.0" <input type="checkbox"/> 15.5" <input type="checkbox"/> 16.0" <input type="checkbox"/> 16.5" <input type="checkbox"/> 17.0" <input type="checkbox"/> 17.5" <input type="checkbox"/> 18.0" <input type="checkbox"/> 18.5" <input type="checkbox"/> 19.0" <input type="checkbox"/> 19.5" .....	\$ STD
---	---	--------

\* Not Available w/ 19.0", 19.5", 20.0", 20.5" Front Seat Height  
 \*Measurement must be 1.5" shorter than your Front Seat Height

<b>HIGH MOUNT</b> <small>With Risers or Clamps</small>	<input type="checkbox"/> 10.0" <input type="checkbox"/> 10.5" <input type="checkbox"/> 11.0" <input type="checkbox"/> 11.5" <input type="checkbox"/> 12.0" <input type="checkbox"/> 12.5" <input type="checkbox"/> 13.0" <input type="checkbox"/> 13.5" <input type="checkbox"/> 14.0" <input type="checkbox"/> 14.5" <input type="checkbox"/> 15.0" <input type="checkbox"/> 15.5" <input type="checkbox"/> 16.0" .....	\$ 65
---	--	-------

<b>12. INSIDE WHEEL CLEARANCE</b>	<input type="checkbox"/> 3/4" * <input type="checkbox"/> 1" <input type="checkbox"/> 1 1/4" <input type="checkbox"/> 1 1/2" <input type="checkbox"/> 1 3/4" <input type="checkbox"/> 2" .....	\$ STD
-----------------------------------	---	--------

\*3/4" Inside wheel clearance not available with 2 degree camber. (with the exception of Y-360 wheels)  
 \*3/4" Inside wheel clearance not available with Armrest \*3/4" Inside wheel clearance not available with D's Locks

**NOTE** Spazz is a custom made wheelchair. If you would like to customize your Spazz beyond what is available on this order form please submit your request here. Colours will determine as to whether this request can be accomplished while maintaining the safety and integrity of the wheelchair. If it can be accomplished the quote will reflect any and all custom charges, thank you.

Sub Total Section B 1/2	\$
Sub Total Section B 2/2	\$
<b>Total Section B</b>	<b>\$</b>

**C WHEELS, TIRES & CASTERS, FORKS 1/2**

WHEELS			
<b>Standard Radial Spoke Wheel</b>	<input type="checkbox"/> 24" (540) Only		\$ STD
<b>Heat-Treated Wheel</b>	<input type="checkbox"/> 24" (540) <input type="checkbox"/> 25" (559) <input type="checkbox"/> 26" (590)		\$ 250
<b>Cross Knot Laced Spokes</b>	<input type="checkbox"/> 24" (540) <input type="checkbox"/> 25" (559) <input type="checkbox"/> 26" (590)		\$ 250
<b>Twister Super Strength Wheel</b>	<input type="checkbox"/> 24" (540) <input type="checkbox"/> 25" (559) <input type="checkbox"/> 26" (590)		\$ 300
<b>SUN Fusion 16 Wheel</b>	<input type="checkbox"/> 24" (540) <input type="checkbox"/> 25" (559)		\$ 410
16 Black Spokes	Hub Color <input type="checkbox"/> Black <input type="checkbox"/> Silver		
<b>Y-360 Billet Wheels</b>	<input type="checkbox"/> 24" (540) <input type="checkbox"/> 25" (559)	Style <input type="checkbox"/> Saw Blade <input type="checkbox"/> Hearts(25"only) <input type="checkbox"/> T-Style(25"only)	\$ 999
*Max. Capacity 220Lbs *Camber 0- 2° max *Not for Sports or Rugged use			
<b>Y-360 Billet Wheels MOD Style</b>	<input type="checkbox"/> 25" (559) Only	Style <input type="checkbox"/> Tribal Sun <input type="checkbox"/> Girls <input type="checkbox"/> Eagle <input type="checkbox"/> Holy Cross <input type="checkbox"/> Hono	\$ 1,499
*Max. Capacity 220Lbs *Camber 0- 2° max *Not for Sports or Rugged use			
Specify Powder Coat Color for Insert Only ( ) *Choose from Frame Colors			
<b>Extra Options for Y-360</b>	<input type="checkbox"/> Spinners Clover ( <b>\$650 up charge</b> ) <input type="checkbox"/> Powder-Coated Spokes Only ( ) *Choose from Frame Colors ( <b>\$150 up charge</b> )		
<b>X-Core (3 Spokes comp)</b>	<input type="checkbox"/> 25" (559) Only	Wheel Color <input type="checkbox"/> Black <input type="checkbox"/> Yellow <input type="checkbox"/> Blue <input type="checkbox"/> Red <input type="checkbox"/> White	\$ 743 \$ 943
*Camber 0- 2° max *Not available with D's Lock *Not available with long tabs			
<b>Spinergy Spox</b>	<input type="checkbox"/> 24" (540) <input type="checkbox"/> 25" (559) <input type="checkbox"/> 26" (590)	Spoke Color <input type="checkbox"/> Black <input type="checkbox"/> Red <input type="checkbox"/> Yellow <input type="checkbox"/> Blue <input type="checkbox"/> White	\$ 695
<b>18 Spokes</b>	With Silver Hub With Black Hub With Black Hub With Black Hub With Black Hub		
	<input type="checkbox"/> Custom Color Spoke Pattern		
	Spokes Color	Inside Outside	Left Wheel Right Wheel
	Hub Color		<input type="checkbox"/> Black/ <input type="checkbox"/> Silver <input type="checkbox"/> Black/ <input type="checkbox"/> Silver
			\$ 795
<b>Spinergy LX</b>	<input type="checkbox"/> 24" (540) <input type="checkbox"/> 25" (559) <input type="checkbox"/> 26" (590)	Spoke Color <input type="checkbox"/> Black <input type="checkbox"/> Red <input type="checkbox"/> Yellow <input type="checkbox"/> Blue <input type="checkbox"/> White <input type="checkbox"/> Neon Green <input type="checkbox"/> Pink <input type="checkbox"/> Orange	\$ 895
<b>12 Spokes</b>	With Silver Hub With Black Hub With Black Hub With Black Hub With Black Hub		
	<input type="checkbox"/> Custom Color Spoke Pattern		
	Spokes Color	Inside Outside	Left Wheel Right Wheel
	Hub Color		<input type="checkbox"/> Black/ <input type="checkbox"/> Silver <input type="checkbox"/> Black/ <input type="checkbox"/> Silver
			\$ 995
<b>Topolino Cabon Core WX2.5 Wheels</b>	Black Spokes Only <input type="checkbox"/> 24" (540) <input type="checkbox"/> 25" (559)	*Max. Capacity 220Lbs	\$ 1,095
*Not available with D's Lock			
	Nipples Color <input type="checkbox"/> Red <input type="checkbox"/> Yellow		
<b>Pro Wheels</b>	<input type="checkbox"/> 24" (540) <input type="checkbox"/> 25" (559)	Spoke & Handrim Color <input type="checkbox"/> Anodized Black <input type="checkbox"/> Anodized Red <input type="checkbox"/> Anodized Blue	\$ 825
w/ Aluminum Color Anodized Handrim *Not available with D's Lock			
HANDRIMS			
<b>Type</b>	<input type="checkbox"/> <b>Standard</b> For 24", 25" or 26" Wheel Anodized Black (*Not available with Pro Wheels)		\$ STD
	<input type="checkbox"/> <b>Vinyl Coated</b> For 24", 25", 26" Wheel (*Not available with Pro Wheels)		\$ 142
	<input type="checkbox"/> <b>Natural Fit</b> For 24", 25" Wheel		
	<input type="checkbox"/> Standard Grip (Not available with short tabs. Not available with Y-360 Billet Wheels, X-Core, Topolino Wheels, Pro Wheels, Mag Wheels)		\$ 295
	<input type="checkbox"/> Super Grip (Not available with short tabs. Not available with Y-360 Billet Wheels, X-Core, Topolino Wheels, Pro Wheels, Mag Wheels)		\$ 340
	<input type="checkbox"/> Without Thumb Grip (Not available with Y-360 Billet Wheels, Not available with Pro Wheels, Mag Wheels)		\$ 270
	<input type="checkbox"/> <b>Natural Fit (LT)</b> For 24", 25" Wheel		
	<input type="checkbox"/> Standard Grip (Not available with short tabs. Not available with Y-360 Billet Wheels, X-Core, Topolino Wheels, Pro Wheels, Mag Wheels)		\$ 325
	<input type="checkbox"/> Super Grip (Not available with short tabs. Not available with Y-360 Billet Wheels, X-Core, Topolino Wheels, Pro Wheels, Mag Wheels)		\$ 370
	<input type="checkbox"/> Without Thumb Grip (Not available with Y-360 Billet Wheels, Not available with Pro Wheels, Mag Wheels)		\$ 300
	<input type="checkbox"/> <b>The Surge Handrims</b> * Not available with Y-360 Billet Wheels * w / X-Core Wheels required Installation fee ( <b>\$30</b> ) flat fee		\$ 315
	<input type="checkbox"/> <b>The Surge Handrims (LT)</b> * Not available with Y-360 Billet Wheels * w / X-Core Wheels required Installation fee ( <b>\$30</b> ) flat fee		\$ 340
	<input type="checkbox"/> <b>Spinergy Flex Rim</b> Available only on 24" and 25" Spinergy LX.		\$ 495
	<input type="checkbox"/> <b>Projections Handrims</b> *Not available with Y-360 Billet Wheels, X-Core, Topolino Wheels, Pro Wheels, Mag Wheels)	<b>E0967</b>	\$ CFP
*Call For Availability			
<b>TAB LENGTH</b>	<input type="checkbox"/> Long Tab ( <b>STD</b> inside clearance 3/4") * Not available with X-Core Wheels		\$ STD
	<input type="checkbox"/> Short Tab (Inside clearance 1/2") *Not available with Ultra Grip and Natural Fit Handrim with thumb grip		\$ STD
	<input type="checkbox"/> Short Tab (Set closest to wheel cut off excess) * Not available with Y-360 wheel, Pro Wheels, X-Core, Pro Wheels		\$ 15

**C WHEELS, TIRES & CASTERS, FORKS 2/2**

TIRES			
<input type="checkbox"/> High Pressure Tire	<input type="checkbox"/> 24"x1", <input type="checkbox"/> 25"x1" or <input type="checkbox"/> 26"x1"	Gray Tire with black wall Only	E2211/E2212 \$ STD
<input type="checkbox"/> High Pressure Tire	<input type="checkbox"/> 24"x1", <input type="checkbox"/> 25"x1" or <input type="checkbox"/> 26"x1"	<input type="checkbox"/> Blue <input type="checkbox"/> Red	E2211/E2212 \$ 65
<input type="checkbox"/> Low Pressure Tire	<input type="checkbox"/> 24"x1-3/8" or <input type="checkbox"/> 26"x1-3/8"	Gray Only	E2211/E2212 \$ STD
<input type="checkbox"/> E2211 Schwalbe Marathon Plus High Pressure Tire	<input type="checkbox"/> 24"x1", <input type="checkbox"/> 25"x1" or <input type="checkbox"/> 26"x1"	Black Only	E2211/E2212 \$ 99
<input type="checkbox"/> Solid Tire	<input type="checkbox"/> 24"x1", <input type="checkbox"/> 25"x1" or <input type="checkbox"/> 26"x1"	<input type="checkbox"/> Dark Gray <input type="checkbox"/> Black( \$30up charge )	E2218 \$ 135
<input type="checkbox"/> E2211 Moderate V-Track Knobby Tire	24"x1-3/8" (37-540)	Gray Only	E2211/E2212 \$ 117
<input type="checkbox"/> E2211 Aggressive Knobby Tire	24"x 2" (50-540)	Gray Only	E2211/E2212 \$ 117
<input type="checkbox"/> E2211 Aggressive Knobby Tire	26"x 1.95" (50-559)	Black Only	E2211/E2212 \$ 117
<input type="checkbox"/> E2213 Flat-Free Inserts For 24"x1-3/8" Tires Only			E2211/E2213 \$ 117

CASTERS					
SIZE	TIRE WIDTH	HUB COLOR	TIRE COLOR	DESCRIPTION	
<input type="checkbox"/> 3"	1"	Black Hub	Black Tire Only	Polyurethane	\$ STD
<input type="checkbox"/> 3"	1"	Plastic Black Hub	Clear Tire Only	Lighted, Polyurethane	\$ 65
<input type="checkbox"/> 3"	1"	Red Hub	Red Tire Only	Polyurethane	\$ STD
<input type="checkbox"/> 3"	1"	Black Hub	Clear Tire Only	Polyurethane	\$ STD
<input type="checkbox"/> 3"	1"	Aluminum Silver Hub	Black Tire Only	Made By Flog Legs	\$ 165
<input type="checkbox"/> 3"	1"	Aluminum Black Hub	Black Tire Only	Made By Flog Legs	\$ 165
<input type="checkbox"/> 3"	1.5"	Aluminum Silver Hub	Black Tire Only	Soft Roll Made By Flog Legs	\$ 165
<input type="checkbox"/> 3"	1.5"	Aluminum Black Hub	Black Tire Only	Soft Roll Made By Flog Legs	\$ 165
<input type="checkbox"/> 4"	1"	Plastic Black Hub	Black Tire Only		\$ STD
<input type="checkbox"/> 4"	1"	Plastic Black Hub	Clear Only	Lighted, Polyurethane	\$ 65
<input type="checkbox"/> 4"	1"	Plastic Black Hub	Black Tire Only	Made By Flog Legs	\$ 125
<input type="checkbox"/> 4"	1"	Aluminum Silver Hub	Black Tire Only	Made By Flog Legs	\$ 165
<input type="checkbox"/> 4"	1"	Aluminum Black Hub	Black Tire Only	Made By Flog Legs	\$ 165
<input type="checkbox"/> 4"	1.5"	Composite Black Hub	Tire <input type="checkbox"/> Black <input type="checkbox"/> Blue <input type="checkbox"/> Red	Soft Roll Made By Flog Legs	\$ 135
<input type="checkbox"/> 4"	1.5"	Aluminum Silver Hub	Tire <input type="checkbox"/> Black <input type="checkbox"/> Blue <input type="checkbox"/> Red	Soft Roll Made By Flog Legs	\$ 165
<input type="checkbox"/> 4"	1.5"	Aluminum Black Hub	Black Tire Only	Soft Roll Made By Flog Legs	\$ 165
<input type="checkbox"/> 5"	1"	Composite Black Hub	Black Tire Only		\$ STD
<input type="checkbox"/> 5"	1"	Plastic Black Hub	Clear Tire Only	Lighted, Polyurethane	\$ 65
<input type="checkbox"/> 5"	1"	Composite Black Hub	Black Tire Only	Made By Flog Legs	\$ 125
<input type="checkbox"/> 5"	1"	Aluminum Silver Hub	Black Tire Only	Made By Flog Legs	\$ 165
<input type="checkbox"/> 5"	1"	Aluminum Black Hub	Black Tire Only	Made By Flog Legs	\$ 165
<input type="checkbox"/> 5"	1.5"	Composite Black Hub	Tire <input type="checkbox"/> Black <input type="checkbox"/> Blue <input type="checkbox"/> Red	Soft Roll Made By Flog Legs	\$ 135
<input type="checkbox"/> 5"	1.5"	Aluminum Silver Hub	Tire <input type="checkbox"/> Black <input type="checkbox"/> Blue <input type="checkbox"/> Red	Soft Roll Made By Flog Legs	\$ 165
<input type="checkbox"/> 5"	1.5"	Aluminum Black Hub	Black Tire Only	Soft Roll Made By Flog Legs	\$ 165

FORKS			
<input type="checkbox"/> STD Aluminum Forks	Black Only		\$ STD
Extra Options for Aluminum Forks	<input type="checkbox"/> With Suspension Springs	E1015	\$ 55
	<input type="checkbox"/> With Quick Release Axles	K0073	\$ 107
<input type="checkbox"/> Frog Leg Suspension Forks	Std 1" Wide (For 3", 4" x 1" width Caster and 5" STD Caster, 5" lighted Caster)	( Not available with Quick Release Axles)	
	Color <input type="checkbox"/> Anodized Black <input type="checkbox"/> Anodized Silver	E1015	\$ 575
<input type="checkbox"/> Frog Leg Suspension Forks	1.5" Wide (For 3", 4" x 1.5" width Caster and 5" x 1"& 5" x 1.5" Casters)	( Not available with Quick Release Axles)	
	Color <input type="checkbox"/> Anodized Black <input type="checkbox"/> Anodized Silver	E1015	\$ 575

Sub Total Section C 1/2	\$
Sub Total Section C 2/2	\$
<b>Total Section C</b>	<b>\$</b>

**D COMPONENTS**

<b>WHEEL LOCKS</b>		
<input type="checkbox"/> Push to Lock / Anodized Black Only		\$ STD
<input type="checkbox"/> NEW Compact Push to Lock / Anodized Black Only <input type="checkbox"/> w/ 2" Extension Handle ( <b>\$65up</b> )		\$ 110
<input type="checkbox"/> NEW Compact Scissor Lock / Anodized Black Only		\$ 110
<input type="checkbox"/> D's Locks (*Not available with X-Core, Topolino WX2.5, Pro Wheels, Magic wheels) (*Does not include installation fee)		\$ CFP
<b>PUSH HANDLES</b> *If you are ordering push handles, You must select the backrest locking mechanism.		
<input type="checkbox"/> Integrated w/Fixed Backrest Height / Anodized Black Only		\$ STD
<input type="checkbox"/> Bolt-on / Anodized Black Only Specify Height from floor -( )		\$ 142
<input type="checkbox"/> Bolt-on w/Quick Release / Anodized Black Only Specify Height from floor -( )		\$ 190
<input type="checkbox"/> NEW Height Adj. / Anodized Black Only Specify Maximum height from floor -( )		\$ 295
<b>NEW ARM RESTS</b> Anodized Black Only,		
<input type="checkbox"/> Fixed Tubular Armrest Adj. Angle and Height Height from seat sling Set at : <input type="checkbox"/> 8" <input type="checkbox"/> 9" <input type="checkbox"/> 10" <input type="checkbox"/> 11" <input type="checkbox"/> 12" E0973		\$ 250
<input type="checkbox"/> Swing Away Tubular Armrest Adj. Angle and Height Height from seat sling Set at : <input type="checkbox"/> 8" <input type="checkbox"/> 9" <input type="checkbox"/> 10" <input type="checkbox"/> 11" <input type="checkbox"/> 12" E0973		\$ 250
<input type="checkbox"/> Flip-Up Armrest <input type="checkbox"/> w/Fixed Tubular Armrest Height from seat sling Set at : <input type="checkbox"/> 8" <input type="checkbox"/> 9" <input type="checkbox"/> 10" <input type="checkbox"/> 11" <input type="checkbox"/> 12" E0973		\$ 250
Adj. Angle <input type="checkbox"/> w/ Swing Away Tubular Armrest Height from seat sling Set at : <input type="checkbox"/> 8" <input type="checkbox"/> 9" <input type="checkbox"/> 10" <input type="checkbox"/> 11" <input type="checkbox"/> 12" E0973		\$ 250
<input type="checkbox"/> Custom Length & Height ( <b>\$150 up charge</b> ) *Specify Height & Length →		
<b>ANTI-TIPPERS</b>		
<input type="checkbox"/> Anti-Tippers (pair) w/ Quick Release / Anodized Black Only		E0971 \$ 112
<b>SIDE GUARDS</b>		
<input type="checkbox"/> Rigid Side Guards - Black ABS <input type="checkbox"/> Non-Removable <input type="checkbox"/> Removable <input type="checkbox"/> Removable w/Hole ( <b>\$10 up charge</b> )	Size: <input type="checkbox"/> STD <input type="checkbox"/> Medium <input type="checkbox"/> Cut to Wheel ( <b>\$98 up charge</b> ) Measurement	\$ 142
Color: Black Only		
<input type="checkbox"/> Rigid Side Guards - Aluminum <input type="checkbox"/> Non-Removable <input type="checkbox"/> Removable	Size: <input type="checkbox"/> Medium Only <input type="checkbox"/> Cut to Wheel ( <b>\$98 up charge</b> ) Measurement	\$ 197
Color <input type="checkbox"/> Black (STD) <input type="checkbox"/> Pol. Aluminum (STD)		
<input type="checkbox"/> Powder Coated ( ) ( <b>\$50 up charge</b> )		
<input type="checkbox"/> Gold Plate (+CFP)		
<input type="checkbox"/> PRO-TEX Fender Guards / (Black ABS -Only) <input type="checkbox"/> Cut to Fit Specs <input type="checkbox"/> Do Not Install		\$ 175
<input type="checkbox"/> Fabric Clothing Guards Black Nylon w/Velcro		\$ 78
<b>SEAT CUSHION</b> -*Please see section E for other cushion choices.-		
<input type="checkbox"/> Foam Cushion w/Nylon Black Cover Thickness <input type="checkbox"/> 1" <input type="checkbox"/> 2" <input type="checkbox"/> 3" <input type="checkbox"/> 4"		\$ 78
<input type="checkbox"/> Custom Cushion Cover (Std. Foam Cushion Only) -Select Fabric ( ) ( <b>\$90 up charge</b> )		
<b>MISCELLANEOUS</b>		
<input type="checkbox"/> Frame Protectors / Black Leather/Zipper Type		\$ 78
<input type="checkbox"/> K0065 Spoke Protectors / Black Only <input type="checkbox"/> 24" <input type="checkbox"/> 25" <input type="checkbox"/> 26" K0065		\$ 107
<input type="checkbox"/> E0978 Seat Belt w/Auto Buckle (BP) 1.5" Black Belt Only E0978		\$ 69
<input type="checkbox"/> Tie Down Brackets 4pcs.		\$ 210
<b>SPECIALTY PARTS</b> <input type="checkbox"/> Wheelchair Tray Size: <input type="checkbox"/> W14"x D12" <input type="checkbox"/> W16"x D14" <input type="checkbox"/> W18"x D14"		
Color: <input type="checkbox"/> Raw Alum. <input type="checkbox"/> Black Alum. <input type="checkbox"/> Polish Alum. ( <b>\$250 up charge</b> )		\$ 250
<b>UPHOLSTERY CHOICE &amp; COLOR</b> *Positioning Back Available. Please see Section E		
<input type="checkbox"/> Standard Adjustable Ht Backrest Black Only		\$ STD
<input type="checkbox"/> Adjustable Tension Backrest Black Only (*Not available with 8" Backrest Height)		\$ 135
Custom Options	<input type="checkbox"/> Fabrics for Fun <input type="checkbox"/> 001 <input type="checkbox"/> 002 <input type="checkbox"/> 003 <input type="checkbox"/> 004 <input type="checkbox"/> 006 <input type="checkbox"/> 010 <input type="checkbox"/> 011 . . . ( <b>\$95 up charge</b> )	
	For Std. or Adj. Style <input type="checkbox"/> 014 <input type="checkbox"/> 015 <input type="checkbox"/> 016 <input type="checkbox"/> 017 <input type="checkbox"/> 018 <input type="checkbox"/> 020 <input type="checkbox"/> 021	
	<input type="checkbox"/> 022 <input type="checkbox"/> 023 <input type="checkbox"/> 024 <input type="checkbox"/> 025 <input type="checkbox"/> 026 <input type="checkbox"/> 027 <input type="checkbox"/> 028	
	<input type="checkbox"/> Backrest Leather Trim (outside panels) . . . . . ( <b>\$77 up charge</b> )	
<input type="checkbox"/> Calf Strap <input type="checkbox"/> Black <input type="checkbox"/> Matching Fabric ( <b>\$55 up charge</b> ) -Select Fabric( )		K0038 \$ 24
<input type="checkbox"/> Matching Fabric on Padded Side Guards -Select Fabric ( )		\$ 210
<b>Total Section D \$</b>		

**E CHAIR OPTIONS 1/2**

SEAT CUSHION			
<b>SUPRACOR® WHEELCHAIR CUSHIONS</b>			
<b>Stimulite® Contoured Cushion</b> *Black Upholstery only	<input type="checkbox"/> W14"xD16" (CD1416) ..... <b>E2603</b> \$ 525 <input type="checkbox"/> W16"xD16" (CD1616) ..... <b>E2603</b> \$ 525 <input type="checkbox"/> W16"xD18" (CD1618) ..... <b>E2603</b> \$ 525 <input type="checkbox"/> W18"xD16" (CD1816) ..... <b>E2603</b> \$ 525 <input type="checkbox"/> W18"xD18" (CD1818) ..... <b>E2603</b> \$ 525 <input type="checkbox"/> W18"xD20" (CD1820) ..... <b>E2603</b> \$ 540 <input type="checkbox"/> W20"xD16" (CD2016) ..... <b>E2603</b> \$ 540 <input type="checkbox"/> W20"xD18" (CD2018) ..... <b>E2603</b> \$ 540 <input type="checkbox"/> W20"xD20" (CD2020) ..... <b>E2603</b> \$ 555	<input type="checkbox"/> Extra Sensitive ( <b>\$30 up charge</b> ) <input type="checkbox"/> Sling Style Bottom ( <b>\$45 up charge</b> ) <input type="checkbox"/> Custom Size W(     " ) x D(     " ) ( <b>-\$ CFP</b> )	
<b>Stimulite® Slimline Cushion</b> *Black Upholstery only	<input type="checkbox"/> W14"xD16" (SM1416) ..... <b>E2603</b> \$ 495 <input type="checkbox"/> W16"xD16" (SM1616) ..... <b>E2603</b> \$ 495 <input type="checkbox"/> W16"xD18" (SM1618) ..... <b>E2603</b> \$ 495 <input type="checkbox"/> W18"xD18" (SM1818) ..... <b>E2603</b> \$ 495 <input type="checkbox"/> W18"xD20" (SM1820) ..... <b>E2603</b> \$ 495 <input type="checkbox"/> W20"xD16" (SM2016) ..... <b>E2603</b> \$ 510 <input type="checkbox"/> W20"xD18" (SM2018) ..... <b>E2603</b> \$ 510 <input type="checkbox"/> W20"xD20" (SM2020) ..... <b>E2603</b> \$ 510	<input type="checkbox"/> Extra Sensitive ( <b>\$30 up charge</b> ) <input type="checkbox"/> Sling Style Bottom ( <b>\$45 up charge</b> ) <input type="checkbox"/> Custom Size W(     " ) x D(     " ) ( <b>-\$ CFP</b> )	
<b>Stimulite® Corbee Pediatric</b> *Black Upholstery only	<input type="checkbox"/> W10"xD10" (PD1010) ..... <b>E2603</b> \$ 450 <input type="checkbox"/> W12"xD12" (PD1212) ..... <b>E2603</b> \$ 450 <input type="checkbox"/> W14"xD14" (PD1414) ..... <b>E2603</b> \$ 450	<input type="checkbox"/> Extra Sensitive ( <b>\$30 up charge</b> ) <input type="checkbox"/> Sling Style Bottom ( <b>\$45 up charge</b> ) <input type="checkbox"/> Custom Size W(     " ) x D(     " ) ( <b>-\$ CFP</b> )	
<b>ROHO WHEELCHAIR CUSHIONS</b>			
<input type="checkbox"/> <b>4" HIGH PROFILE® QUADTRO SELECT® CUSHION</b> Choose Size	<input type="checkbox"/> W12"xD12" <input type="checkbox"/> W12"xD13" <input type="checkbox"/> W13"xD13" <input type="checkbox"/> W13"xD15" <input type="checkbox"/> W13"xD16" <input type="checkbox"/> W15"xD13" <input type="checkbox"/> W15"xD15" <input type="checkbox"/> W15"xD16" <input type="checkbox"/> W15"xD18" <input type="checkbox"/> W16"xD15" <input type="checkbox"/> W16"xD16" <input type="checkbox"/> W16"xD18" <input type="checkbox"/> W16"xD20" <input type="checkbox"/> W18"xD15" <input type="checkbox"/> W18"xD16" <input type="checkbox"/> W18"xD18" <input type="checkbox"/> W18"xD20" <input type="checkbox"/> W18"xD22" <input type="checkbox"/> W20"xD16" <input type="checkbox"/> W20"xD18" <input type="checkbox"/> W20"xD20" <input type="checkbox"/> W20"xD22" <input type="checkbox"/> W22"xD18" <input type="checkbox"/> W22"xD20" <input type="checkbox"/> W22"xD22" <input type="checkbox"/> Custom Size W(     " ) x D(     " ) ( <b>+\$85</b> )	*Black Upholstery ..... <b>E2622-2623</b>	\$ 525
<input type="checkbox"/> <b>3" MID PROFILE® QUADTRO SELECT® CUSHION</b> Choose Size	<input type="checkbox"/> W15"xD15" <input type="checkbox"/> W15"xD16" <input type="checkbox"/> W16"xD16" <input type="checkbox"/> W16"xD18" <input type="checkbox"/> W18"xD16" <input type="checkbox"/> W18"xD18" <input type="checkbox"/> Custom Size W(     " ) x D(     " ) ( <b>+\$85</b> )	*Black Upholstery only ..... <b>E2622-2623</b>	\$ 525
<input type="checkbox"/> <b>2" LOW PROFILE® QUADTRO SELECT® CUSHION</b> Choose Size	<input type="checkbox"/> W12"xD12" <input type="checkbox"/> W12"xD13" <input type="checkbox"/> W13"xD13" <input type="checkbox"/> W13"xD15" <input type="checkbox"/> W13"xD16" <input type="checkbox"/> W15"xD13" <input type="checkbox"/> W15"xD15" <input type="checkbox"/> W15"xD16" <input type="checkbox"/> W15"xD18" <input type="checkbox"/> W16"xD15" <input type="checkbox"/> W16"xD16" <input type="checkbox"/> W16"xD18" <input type="checkbox"/> W16"xD20" <input type="checkbox"/> W18"xD15" <input type="checkbox"/> W18"xD16" <input type="checkbox"/> W18"xD18" <input type="checkbox"/> W18"xD20" <input type="checkbox"/> W20"xD16" <input type="checkbox"/> W20"xD18" <input type="checkbox"/> W20"xD20" <input type="checkbox"/> Custom Size W(     " ) x D(     " ) ( <b>+\$85</b> )	*Black Upholstery only ..... <b>E2622-2623</b>	\$ 525
<input type="checkbox"/> <b>2" NEXUS SPIRIT® CUSHION</b> Choose Size	<input type="checkbox"/> W14"xD14" <input type="checkbox"/> W14"xD16" <input type="checkbox"/> W15"xD15" <input type="checkbox"/> W16"xD16" <input type="checkbox"/> W16"xD18" <input type="checkbox"/> W17"xD17" <input type="checkbox"/> W18"xD16" <input type="checkbox"/> W18"xD18" <input type="checkbox"/> W20"xD18"	*Black Upholstery only ..... <b>E2622</b> * Custom Size Not Available	\$ 525
<b>STAR CUSHIONS</b>			
<b>Galaxy Cushion</b> *Black Upholstery only	<input type="checkbox"/> W14"xD14" ( GXY 1414-2) <input type="checkbox"/> W14"xD16" ( GXY 1416-2) <input type="checkbox"/> W16"xD14" ( GXY 1614-2) <input type="checkbox"/> W16"xD16" ( GXY 1616-2) <input type="checkbox"/> W16"xD18" ( GXY 1618-2) <input type="checkbox"/> W18"xD16" ( GXY 1816-2)   ⇒ <input type="checkbox"/> W18"xD18" ( GXY 1818-2) <input type="checkbox"/> W18"xD20" ( GXY 1820-2) <input type="checkbox"/> W20"xD16" ( GXY 2016-2) <input type="checkbox"/> W20"xD18" ( GXY 2018-2) <input type="checkbox"/> W20"xD20" ( GXY 2020-2)	Choose Zoning Options <input type="checkbox"/> Standard - Dual Valve <input type="checkbox"/> Dual Valve - Front to Back <input type="checkbox"/> Four Valve <input type="checkbox"/> Simple - Single Valve <input type="checkbox"/> Four Valve - Enhanced <input type="checkbox"/> Four Valve - Front to Back	<b>E2624</b> \$ 498
<b>THE CURVE CUSHION</b> *Black Upholstery only	<input type="checkbox"/> W10"xD10" <input type="checkbox"/> W10"xD11" <input type="checkbox"/> W10"xD11" <input type="checkbox"/> W10"xD12" <input type="checkbox"/> W11"xD12" <input type="checkbox"/> W12"xD12" <input type="checkbox"/> W12"xD13" <input type="checkbox"/> W12"xD14" <input type="checkbox"/> W13"xD11" <input type="checkbox"/> W13"xD12" <input type="checkbox"/> W13"xD13" <input type="checkbox"/> W13"xD14" <input type="checkbox"/> W14"xD14" <input type="checkbox"/> W14"xD15" <input type="checkbox"/> W14"xD16" <input type="checkbox"/> W15"xD14" <input type="checkbox"/> W15"xD15" <input type="checkbox"/> W15"xD16" <input type="checkbox"/> W16"xD14" <input type="checkbox"/> W16"xD15" <input type="checkbox"/> W16"xD16" <input type="checkbox"/> W16"xD17" <input type="checkbox"/> W16"xD18" <input type="checkbox"/> W17"xD16" <input type="checkbox"/> W17"xD17" <input type="checkbox"/> W17"xD18" <input type="checkbox"/> W18"xD16" <input type="checkbox"/> W18"xD17" <input type="checkbox"/> W18"xD18"		\$ 133
<b>NOTE</b>			

**E CHAIR OPTIONS 2/2**

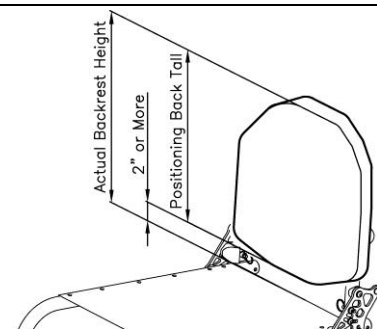
<b>POSITIONING BACK</b>			
<p><b>*Note : Actual height of the backrest will increase 2" or more.</b></p> 			
<p><b>ADI CARBON BACKREST (Support Contour-ACTIVE 2.5")</b> *Not Available with Welded Side Guards</p> <p>Mounting Hardware: <input type="checkbox"/> 2 Point Pro    <input type="checkbox"/> Quick Release</p>			
Height	<input type="checkbox"/> <b>LOW</b> (10" Tall) *Backrest Height requires 12" or more *Available 13"-19" width    Width (    ") <b>E2613</b> \$ 745 <input type="checkbox"/> <b>Medium</b> (13" Tall) *Backrest Height requires 15" or more *Available 13"-19" width    Width (    ") <b>E2613</b> \$ 815 <input type="checkbox"/> <b>Standard</b> (16" Tall) *Backrest Height requires 18" or more *Available 13"-19" width    Width (    ") <b>E2613</b> \$ 880 <input type="checkbox"/> <b>Custom Size</b> (    " Tall ) x (    " width ) . . . . . <b>E2613</b> \$ CFP		
<p><b>ADI ALUMINUM BACKREST (Support Contour-ACTIVE 2.5")</b> *Not Available with Welded Side Guards</p> <p>Mounting Hardware: <input type="checkbox"/> 2 Point Pro    <input type="checkbox"/> Quick Release</p>			
Height	<input type="checkbox"/> <b>LOW</b> (10" Tall) *Backrest Height requires 12" or more *Available 10"-20" width    Width (    ") <b>E2613</b> \$ 610 <input type="checkbox"/> <b>Medium</b> (13" Tall) *Backrest Height requires 15" or more *Available 12"-20" width    Width (    ") <b>E2613</b> \$ 625 <input type="checkbox"/> <b>Standard</b> (16" Tall) *Backrest Height requires 18" or more *Available 14"-20" width    Width (    ") <b>E2613</b> \$ 640 <input type="checkbox"/> <b>Tall</b> (18" Tall) *Backrest Height requires 20" or more *Available 16"-20" width    Width (    ") <b>E2613</b> \$ 655 <input type="checkbox"/> <b>X-Tall</b> (20" Tall) *Backrest Height requires 22" or more *Available 16"-20" width    Width (    ") <b>E2613</b> \$ 670 <input type="checkbox"/> <b>Custom Size</b> (    " Tall ) x (    " width ) . . . . . <b>E2613</b> \$ CFP		
<p><b>ADI ALUMINUM BACKREST (Support Contour-DEEP 4")</b> *Not Available with Welded Side Guards *Not Available with Lateral Supports</p> <p>Mounting Hardware: <input type="checkbox"/> 2 Point Pro    <input type="checkbox"/> Quick Release</p>			
Height	<input type="checkbox"/> <b>LOW</b> (10" Tall) *Backrest Height requires 12" or more *Available 10"-20" width    Width (    ") <b>E2615</b> \$ 710 <input type="checkbox"/> <b>Medium</b> (13" Tall) *Backrest Height requires 15" or more *Available 12"-20" width    Width (    ") <b>E2615</b> \$ 725 <input type="checkbox"/> <b>Standard</b> (16" Tall) *Backrest Height requires 18" or more *Available 14"-20" width    Width (    ") <b>E2615</b> \$ 740 <input type="checkbox"/> <b>Tall</b> (18" Tall) *Backrest Height requires 20" or more *Available 16"-20" width    Width (    ") <b>E2615</b> \$ 755 <input type="checkbox"/> <b>X-Tall</b> (20" Tall) *Backrest Height requires 22" or more *Available 16"-20" width    Width (    ") <b>E2615</b> \$ 770 <input type="checkbox"/> <b>Custom Size</b> (    " Tall ) x (    " width ) . . . . . <b>E2615</b> \$ CFP		
<p><b>ADI LATERAL SUPPORTS ( Lateral Supports are compatible with only active 2.5" ADI positioning back. )</b></p> <p><input type="checkbox"/> <b>Stationary Pad</b>    Pad Size    <input type="checkbox"/> Small (3" H x 3" D)    <input type="checkbox"/> Medium(3" H x 4" D)    <input type="checkbox"/> Large(4.5" H x 4.5" D)    <input type="checkbox"/> Large(4" H x 6" D)</p> <p>    <input type="checkbox"/> Pair . . . . . \$ 320</p> <p>    <input type="checkbox"/> Left side only    or    <input type="checkbox"/> Right side only . . . . . \$ 160</p> <p><input type="checkbox"/> <b>Swing-Out</b>    Pad Size    <input type="checkbox"/> Small (3" H x 3" D)    <input type="checkbox"/> Medium(3" H x 4" D)    <input type="checkbox"/> Large(4.5" H x 4.5" D)    <input type="checkbox"/> Large(4" H x 6" D)</p> <p>    <input type="checkbox"/> Pair . . . . . \$ 520</p> <p>    <input type="checkbox"/> Left side only    or    <input type="checkbox"/> Right side only . . . . . \$ 260</p>			
<b>OTHER</b>			
<input type="checkbox"/> <b>ADI Transfer Board</b> <input type="checkbox"/> 21" (ADV21) <input type="checkbox"/> 24" (ADV24) <input type="checkbox"/> 29" . . . . . \$ 62			
<input type="checkbox"/> <b>ADI Push and Transfer Gloves</b> <b>Leather</b> (one size fits) . . . . . \$ 60			
<input type="checkbox"/> <b>ADI Carbon Solid Seat</b> (Wide: 18" Max, Depth: 20" )    ※Colours Side Guards Not Available with ADI Carbon Solid Seat \$ 625			
With / <input type="checkbox"/> <b>ADI Folding Carbon Side Guard</b> . . . . . \$ 400			
With / <input type="checkbox"/> <b>ADI Fixed Carbon Side Guard</b> . . . . . \$ 375			
<p><b>VARILITE® Seating Systems Available</b></p> <p style="text-align: right;">Please visit for all options. <a href="http://www.varilite.com">www.varilite.com</a></p>			CFP
<b>NOTE</b>			
		<b>Sub Total Section E 1/2</b>	\$
		<b>Sub Total Section E 2/2</b>	\$
		<b>Total Section E</b>	\$



**F SPECIAL PARTS COLORS ( Please allow an additional 1-2 weeks delivery)**

**PARTS COLORS**

<b>Powder-Coated</b>	Gloss Black	Twilight Flake	Yellow	Magenta	Fire Engine Red	White
	Candy Blue	Candy Purple	Candy Green	Candy Red	Candy Raspberry	Cobalt Blue
	Matte Gray	Matte Purple	Matte Blue	Matte Green	Matte Black	Matte Red
	Neon Red	Neon Green	Orange Sparkle	Mellon Yellow	Gun Smoke Silver	Pigeon Blue
		Granny Sparkle Green	Sparkle Sky Blue	Vermilion	Reed Green	Blue Lilac

**Special Colors** Polished Aluminum  
24 karat Gold Plated

**Please Choose the Color for each Part**

\*Parts not selected will be black color. (Suspension Spring: Silver Color)

\*Minimum 3 parts selected per order.

\*PC=Powder-Coated

**Saddle Stops**

<input type="checkbox"/> PC ( )	\$40
<input type="checkbox"/> Polished	\$115
<input type="checkbox"/> Gold Plated	\$CFP

**Backrest**

<input type="checkbox"/> PC ( )	\$125
<input type="checkbox"/> Polished	\$225
<input type="checkbox"/> Gold Plated	\$CFP

**Backrest Brackets**

<input type="checkbox"/> PC ( )	\$90
<input type="checkbox"/> Polished	\$115
<input type="checkbox"/> Gold Plated	\$CFP

**Caps**

<input type="checkbox"/> PC ( )	\$20
<input type="checkbox"/> Polished	N/A
<input type="checkbox"/> Gold Plated	N/A

**Caster Housing**

<input type="checkbox"/> PC ( )	\$150
<input type="checkbox"/> Polished	\$280
<input type="checkbox"/> Gold Plated	N/A

**Front Springs**

<input type="checkbox"/> PC ( )	\$20
<input type="checkbox"/> Polished	N/A
<input type="checkbox"/> Gold Plated	N/A

**Forks & Knurl Nuts**

<input type="checkbox"/> PC ( )	\$65
<input type="checkbox"/> Polished	\$90
<input type="checkbox"/> Gold Plated	\$CFP

**Axle Plates**

<input type="checkbox"/> PC ( )	\$65
<input type="checkbox"/> Polished	\$85
<input type="checkbox"/> Gold Plated	\$CFP

**Camber Plates**

<input type="checkbox"/> PC ( )	\$50
<input type="checkbox"/> Polished	\$75
<input type="checkbox"/> Gold Plated	\$CFP

**Axle Tube**

<input type="checkbox"/> PC ( )	\$50
<input type="checkbox"/> Polished	\$75
<input type="checkbox"/> Gold Plated	\$CFP

**Axle Clamps**

<input type="checkbox"/> PC ( )	\$50
<input type="checkbox"/> Polished	\$75
<input type="checkbox"/> Gold Plated	\$CFP

**Axle Bases**

<input type="checkbox"/> PC ( )	\$50
<input type="checkbox"/> Polished	\$75
<input type="checkbox"/> Gold Plated	\$CFP

**Footrest Rings**

<input type="checkbox"/> PC ( )	\$20
<input type="checkbox"/> Polished	\$40
<input type="checkbox"/> Gold Plated	\$CFP

**Footrest Tubes**

<input type="checkbox"/> PC ( )	\$65
<input type="checkbox"/> Polished	\$85
<input type="checkbox"/> Gold Plated	\$CFP

**Foot Plate Clamps**

<input type="checkbox"/> PC ( )	\$50
<input type="checkbox"/> Polished	\$75
<input type="checkbox"/> Gold Plated	\$CFP

**Foot Plate**

<input type="checkbox"/> PC ( )	\$45
<input type="checkbox"/> Polished	\$90
<input type="checkbox"/> Gold Plated	\$CFP

**Total Section F \$**

## 1. SEAT WIDTH

Measure from outside of seat tube to the outside of the opposite seat tube.

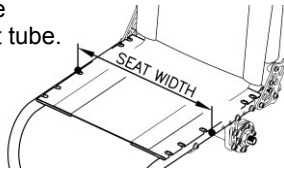

## 2. SEAT DEPTH

Measure from at the front bottom of backrest tube to the front edge of seat sling.

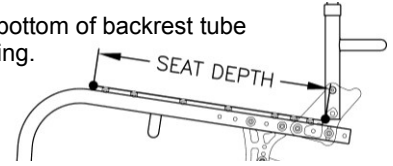

## 3. FOOTREST WIDTH

Measure from inside of front frame tube to inside of opposite front frame tube.

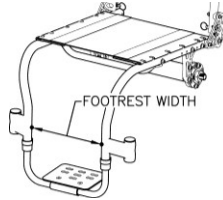

## 4. FRAME ANGLE

Measure angle frame front to floor.

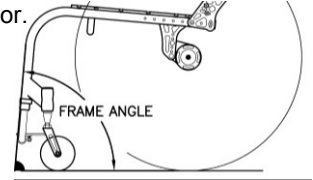

## 5. BACKREST HEIGHT

Measure from top of back post to seat sling at front bottom of backrest tube.

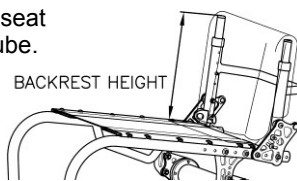

## 6. BACKREST ANGLE

Measure angle from front of back post to floor.

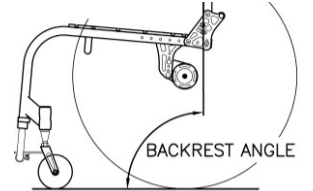

## 7. FRONT SEAT HEIGHT

Measure from floor to top of seat sling at front edge.

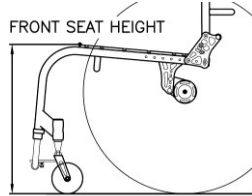

## 8. REAR SEAT HEIGHT

Measure from floor to top of seat sling at front bottom of backrest tube.

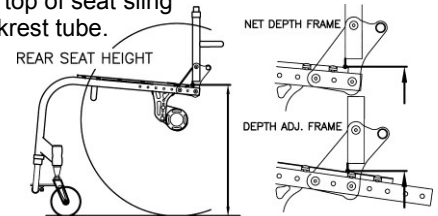

## 9. CENTER OF GRAVITY

Measure from center of back tube at the folding pivot to the center of the rear axle.

( If welding backrest is selected, Measure from center of back tube at the seat tube to the center of the rear axle. )

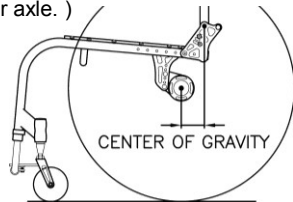

## 10. CAMBER ANGLE

Measure angle from wheel to vertical at floor.

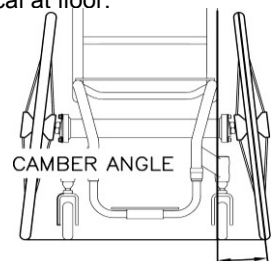

## 11. FRONT OF SEAT SLING TO FOOTREST

### ADULT CHAIR

Measure from top of seat sling at front edge to top of foot plate at front edge.

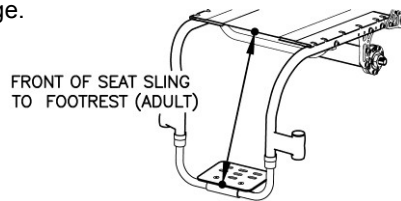

### PEDIATRIC CHAIR

Measure vertical from top of seat sling at front edge to top of foot plate.

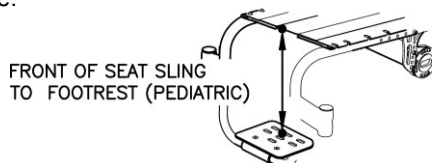

## 12. INSIDE WHEEL CLEARANCE

Measure from outside of seat back tube to inside of rear tire.

( If side guards are selected, measure from outside of side guards to inside of rear tire.)

